



Kitchen Cabinet Frames

OMMA
MONTERING





OMMA

MONTERING

**Wide selection, high quality,
and fast delivery.**

For technical printing reasons, colors may
differ from the original



- The bottom panel has positions for quick-release plinth legs:
 - - 150 mm (adjustment range 130 - 190 mm)
 - - 100 mm (adjustment range 100 - 130 mm)
- Plinth leg made of recyclable plastic



- The side drillings of the cabinet include holes for hinge mounting plates, and metal drawers and profile drawers from different suppliers.
- The cabinet frames are packed individually by cabinet in cardboard packaging. Detailed assembly instructions are included in the package.



Technical Specifications

- The cabinet frames are manufactured from 16 mm white melamine-faced chipboard.
- The quality classification of the board is E1.
- A 3.2 mm thick HDF board is used as the back panel.
- The surface color of the back panel is white.
- All visible edges of the cabinet frame are edge-banded with 0.8 mm thick ABS edge banding.
- The assembly of the cabinet frame is done with wooden dowels and assembly screws.
- Assembly does not require the use of glue.
- The moisture-resistant wall and base cabinet frames in our selection are manufactured from moisture-resistant chipboard with a P3 moisture classification.

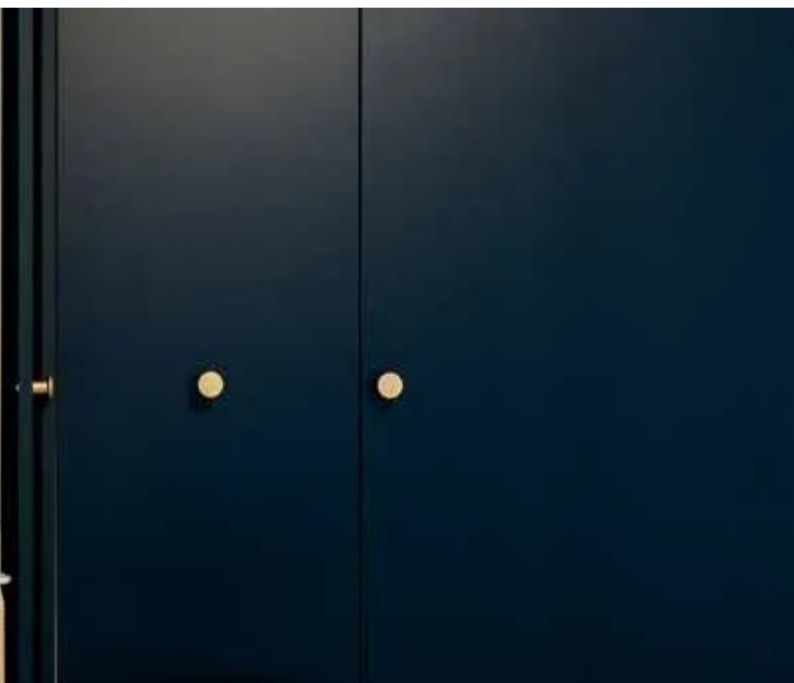
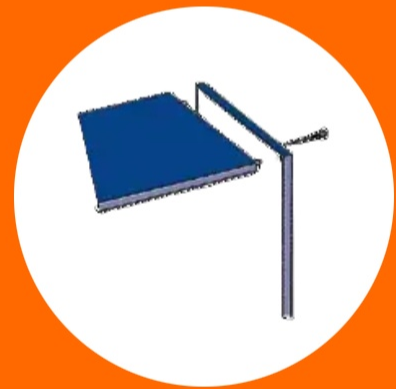

TECHNICAL SPECIFICATIONS

FRAME DIMENSIONS

2362 mm

2082 mm

1910 mm

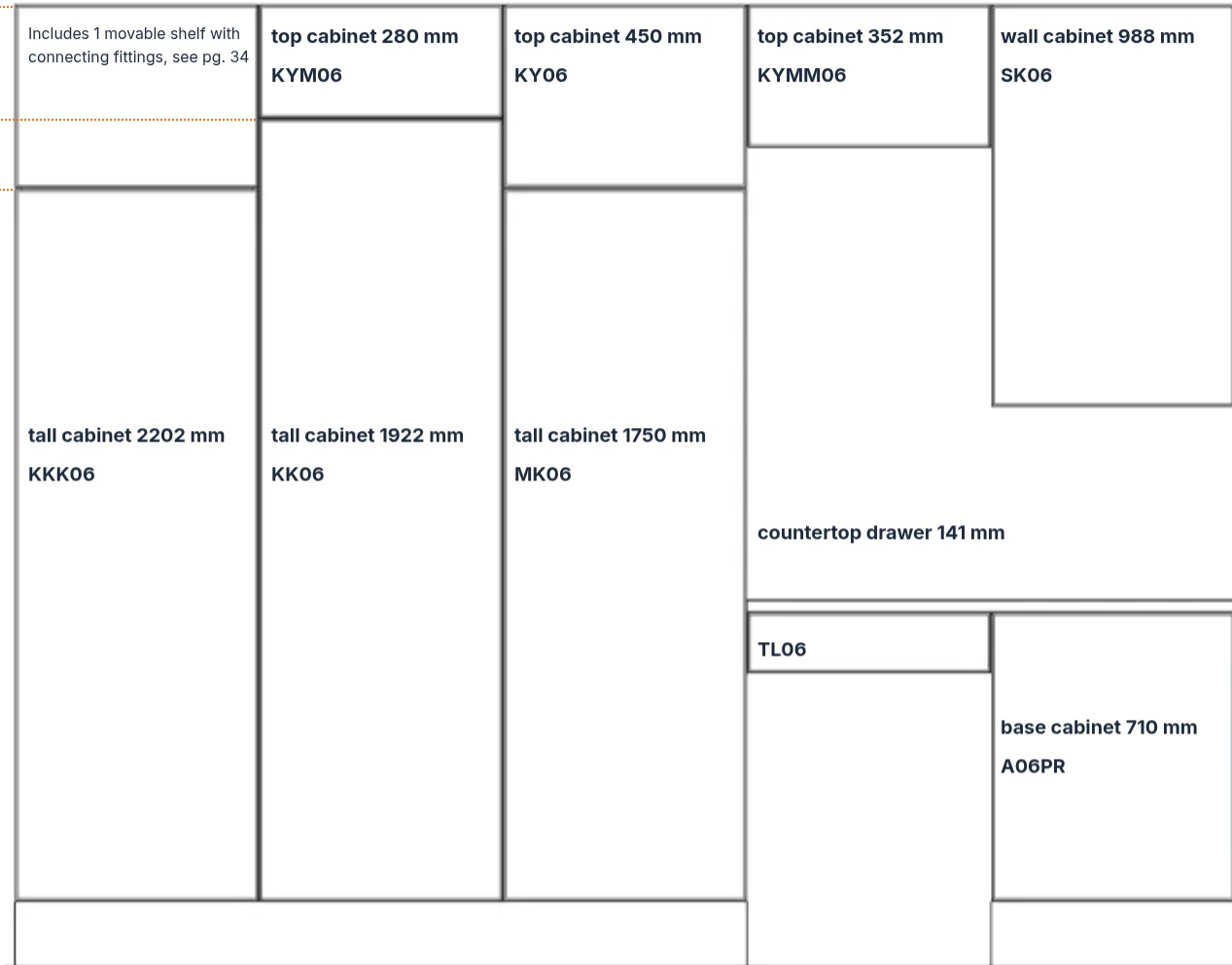

TECHNICAL SPECIFICATIONS

FRAME DIMENSIONS

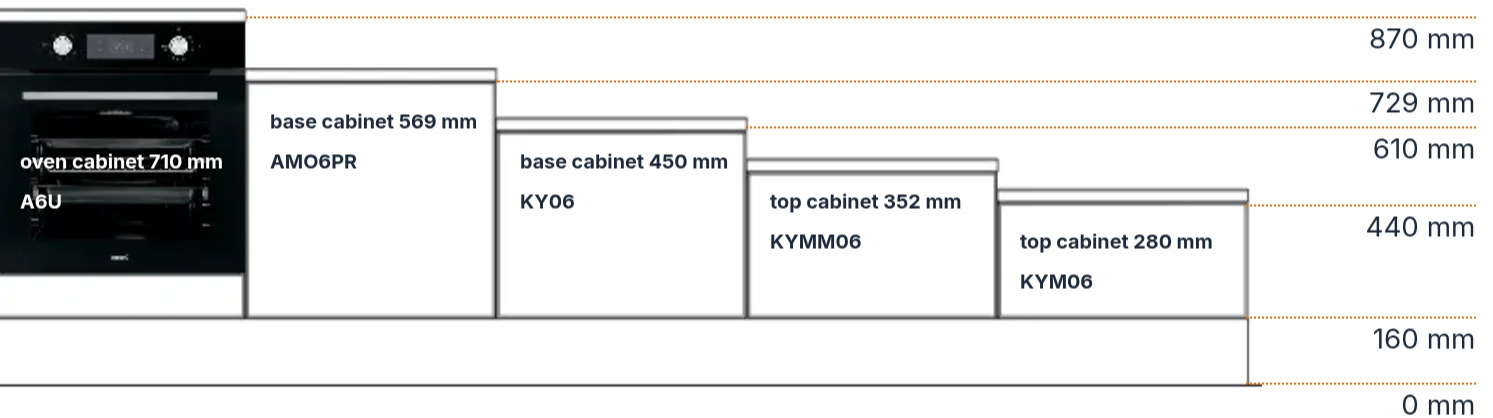
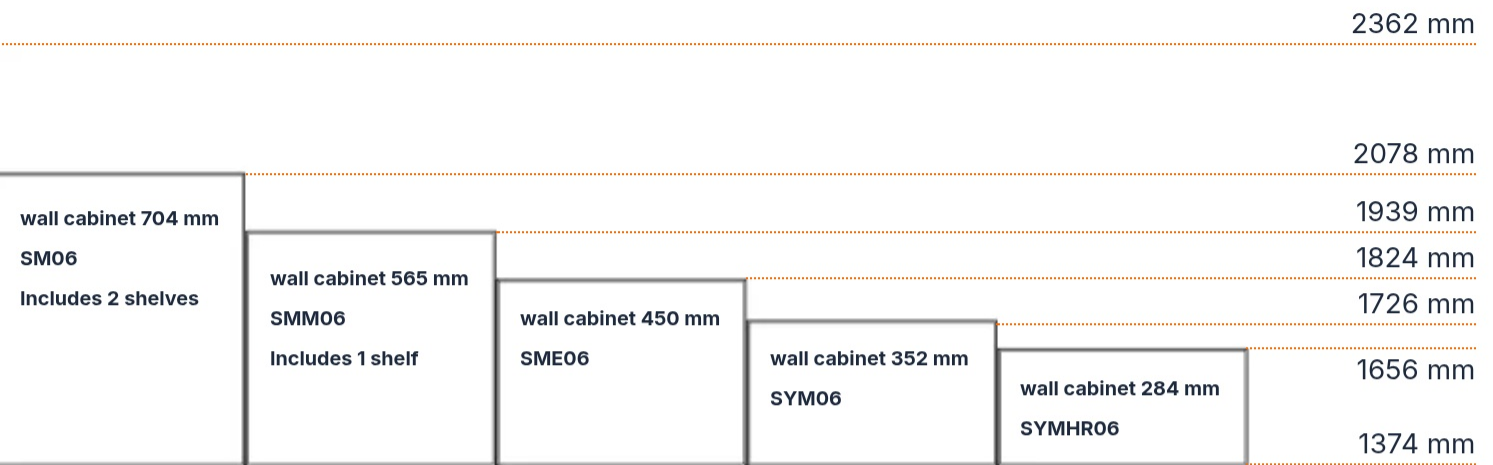

TECHNICAL SPECIFICATIONS

FRAME DIMENSIONS 2362 MM HEIGHT

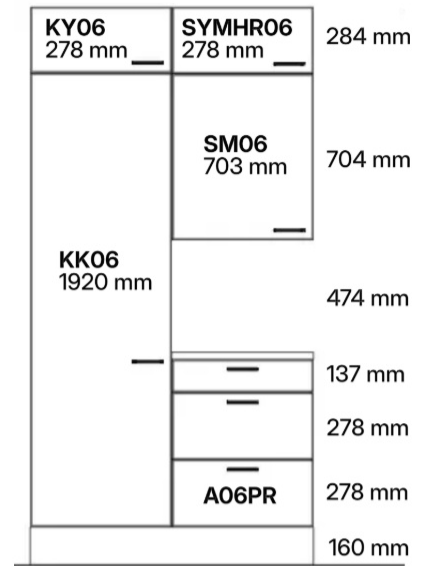
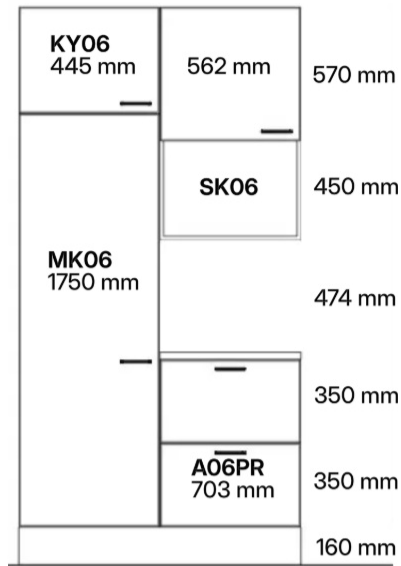
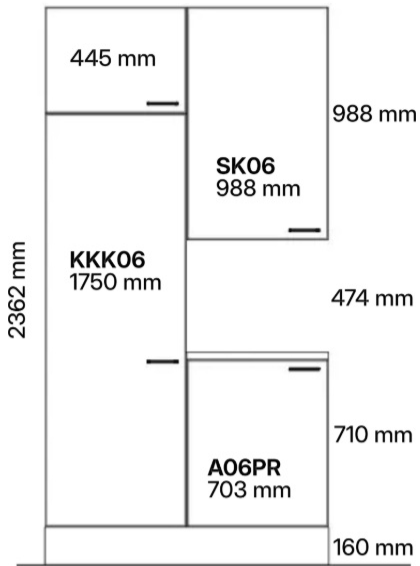

Side profile 2362 mm

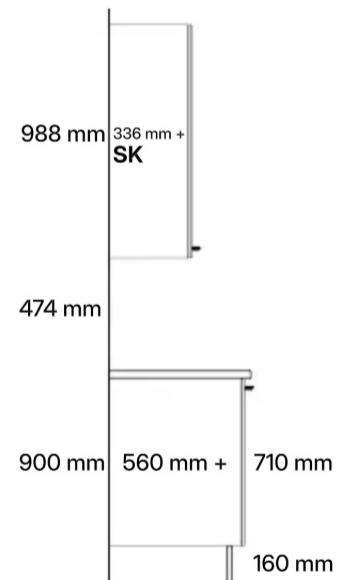
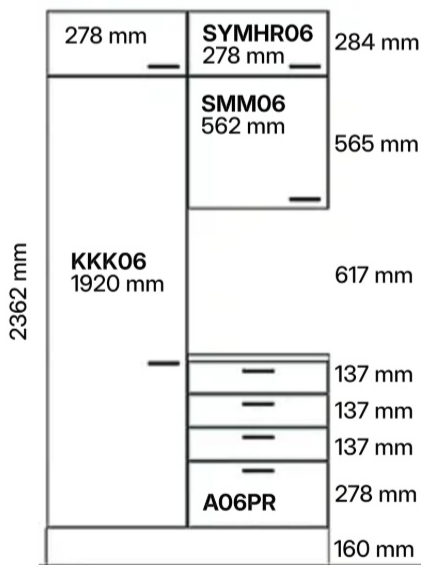

TECHNICAL SPECIFICATIONS

FRAME DIMENSIONS 2082 MM HEIGHT

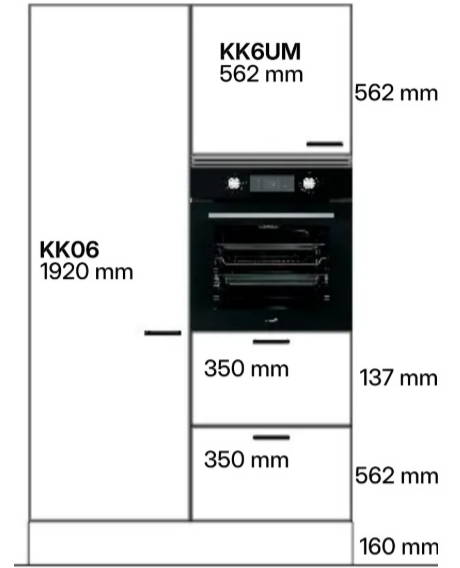
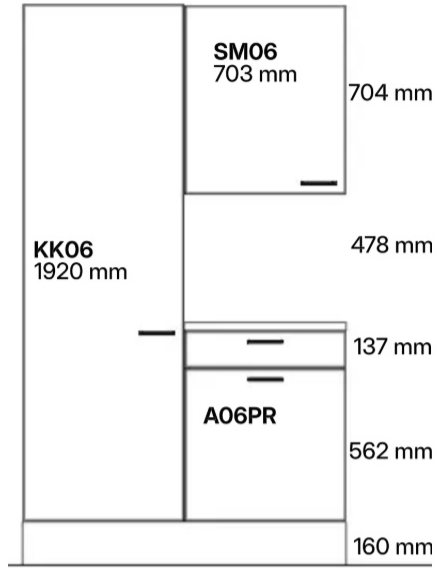
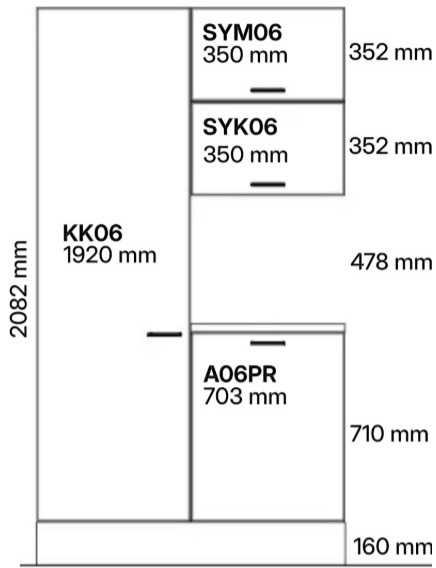

Side profile 2082 mm

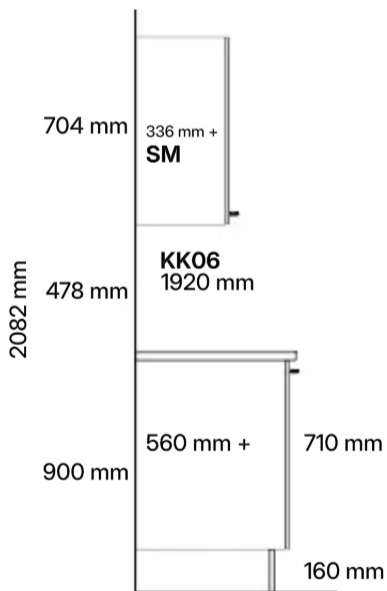

1. Base and wall corner cabinet dimensioning

935*935 & 635*635 mm

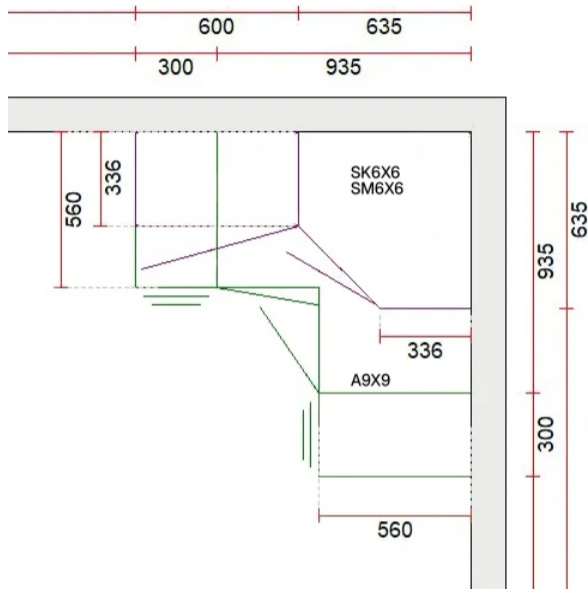

2. Blind corner:

900 mm with 446 mm door

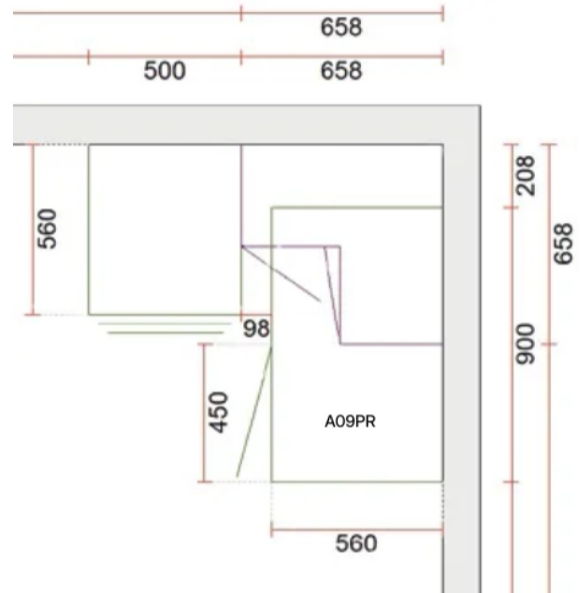

3. Corner cabinet dimensioning stove corner:

600 mm

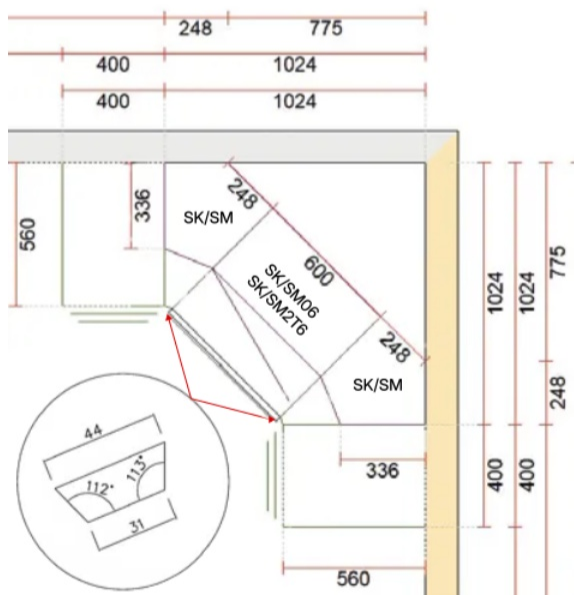

4. Blind corner dimensioning:

900 mm with 396mm door

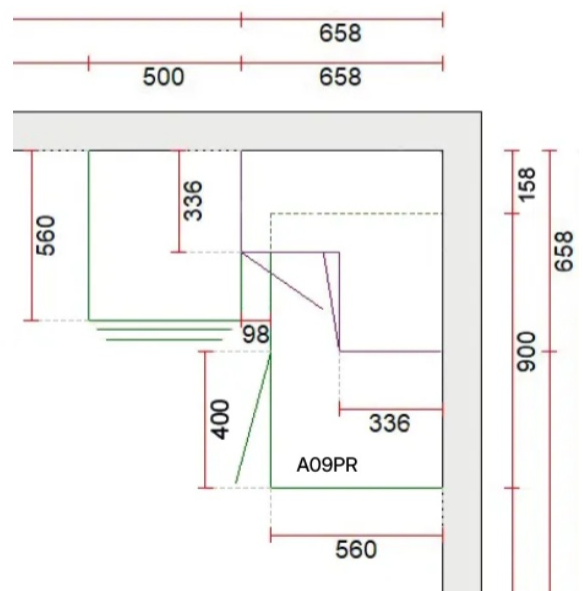

5. Blind corner dimensioning:
1000 mm with 396 mm door

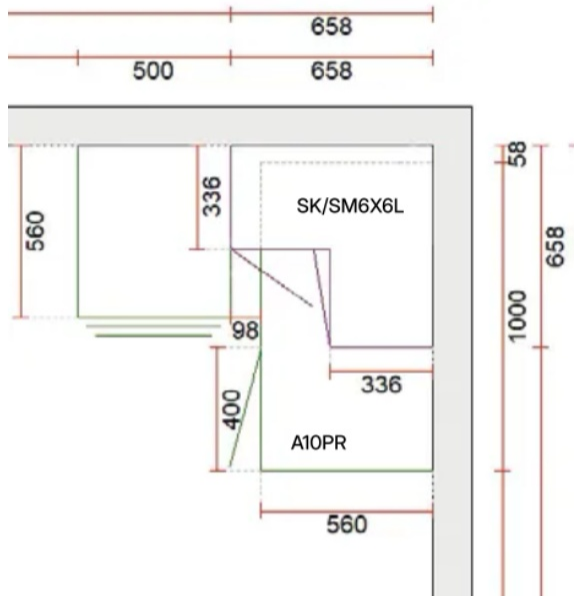

6. Blind corner dimensioning:
1200 mm with 596 mm door

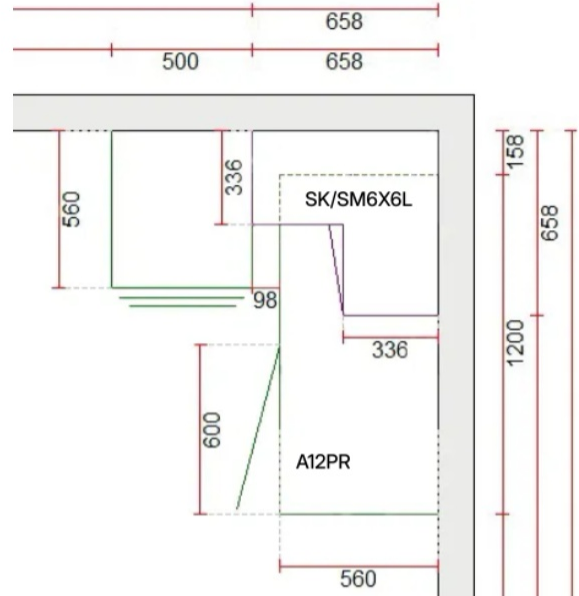

7. Blind corner dimensioning:
1000 mm with 496 mm door

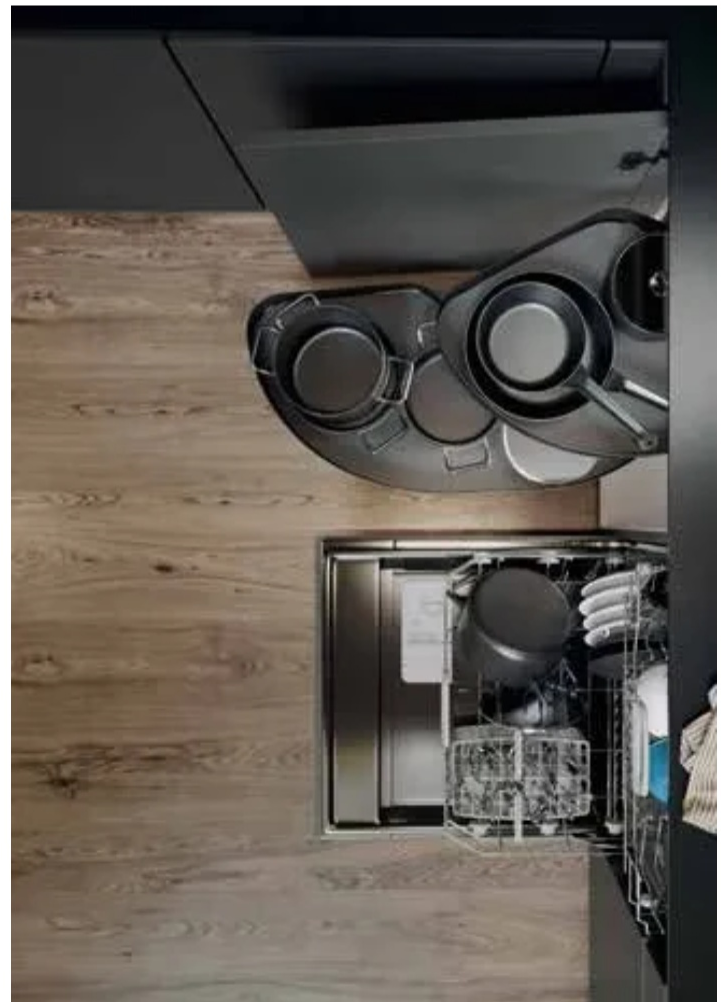
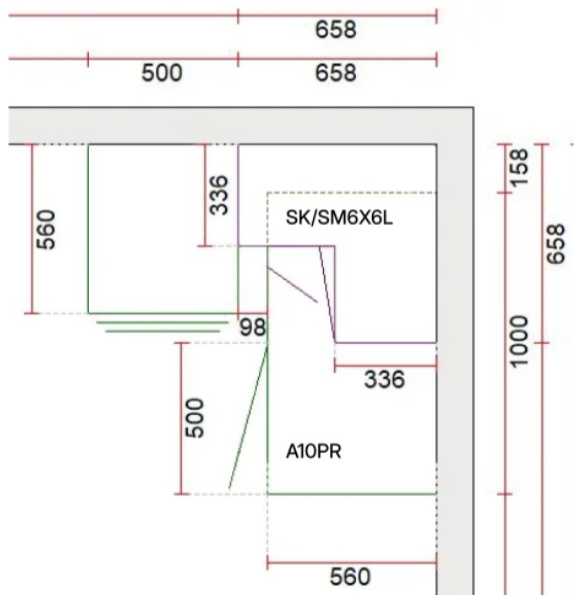





Base cabinets

- Height 710 mm (also available in 569 mm height)
- Frame outer depth 560 mm
- Back panel always grooved in
- Shelf available as an accessory to order.
- In addition to standard sizes, frames are available in custom sizes and colors. The made-to-order frame colors are white, oak, and anthracite.

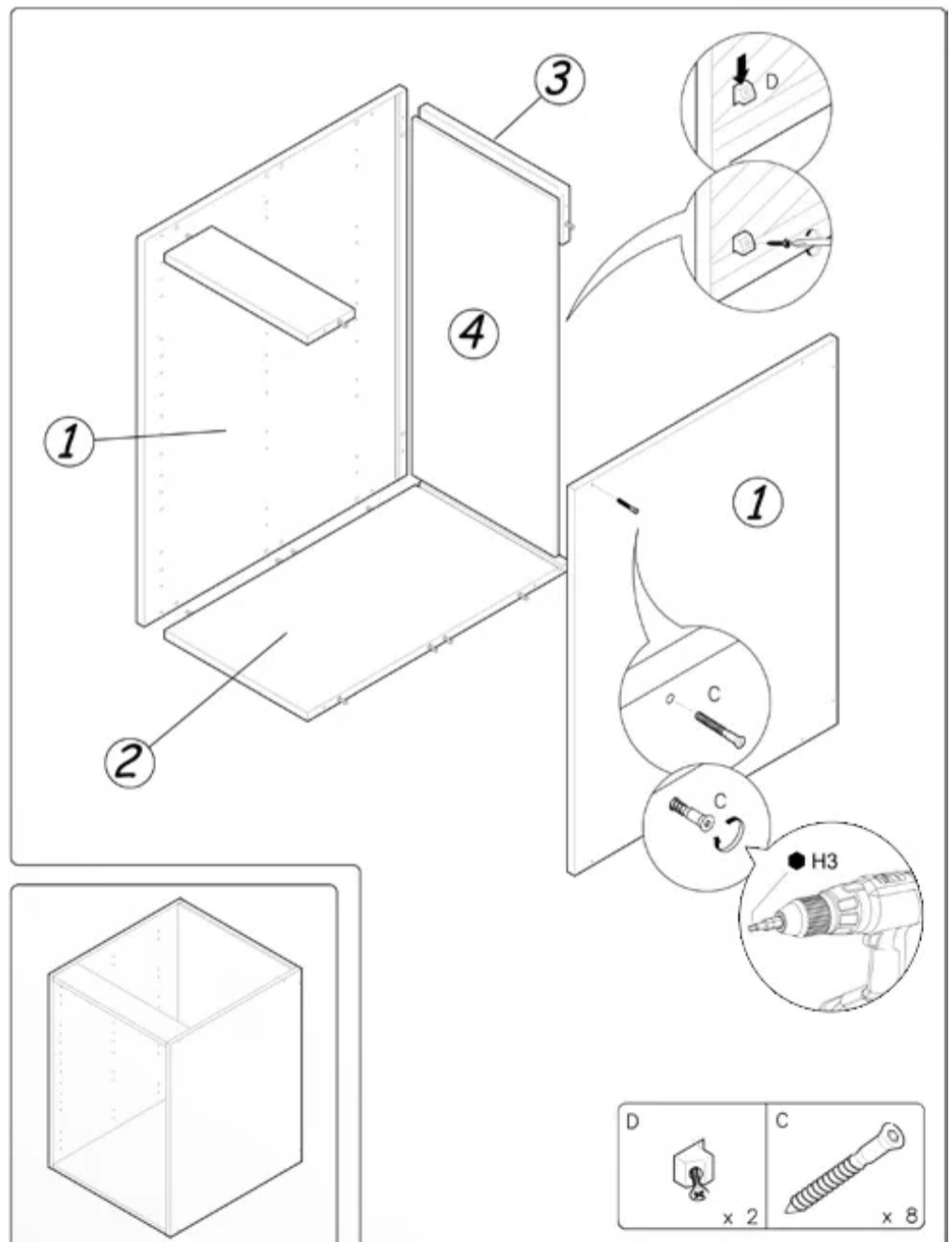

Base cabinets



BASE CABINET H. 710, D. 560 MM

Code	Description	NLK
A02PR	BASE CABINET 710*200*560	3020
A03PR	BASE CABINET 710*300*560	3020
A04PR	BASE CABINET 710*400*560	3020
A045PR	BASE CABINET 710*450*560	3020
A05PR	BASE CABINET 710*500*560	3020
A06PR	BASE CABINET 710*600*560	3020
A07PR	BASE CABINET 710*700*560	3020
A08PR	BASE CABINET 710*800*560	3020
A09PR	BASE CABINET 710*900*560	3020
A10PR	BASE CABINET 710*1000*560	3020
A12PR	BASE CABINET 710*1200*560	3020

Moisture-resistant (P3)

Code	Description	NLK
A04PRKK	BASE CABINET MR 710*400*560	3029
A05PRKK	BASE CABINET MR 710*500*560	3029
A06PRKK	BASE CABINET MR 710*600*560	3029
A08PRKK	BASE CABINET MR 710*800*560	3029
A10PRKK	BASE CABINET MR 710*1000*560	3029

Plinth legs and shelves are not included in the frame package.

A02PR frame has drillings for SUB SIDE mechanism

Profile drawers

- Drilling for side-hinged door 100 mm from door ends
- Frame has drillings for drawer runners.

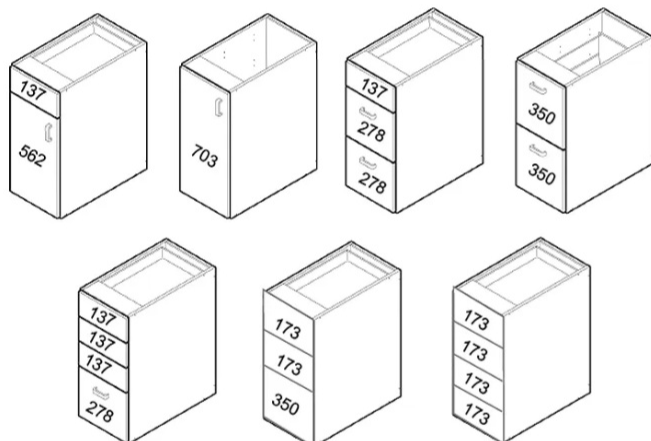

LOW BASE CABINET H. 569, D. 560 MM

Code	Description	NLK
AM04PR	LOW BASE CABINET 569*400*560	3023
AM05PR	LOW BASE CABINET 569*500*560	3023
AM06PR	LOW BASE CABINET 569*600*560	3023
AM08PR	LOW BASE CABINET 569*800*560	3023

Plinth legs and shelves are not included in the frame package.

Profile drawers

- Drilling for side-hinged door 100 mm from door ends
- Frame has drillings for drawer runners.

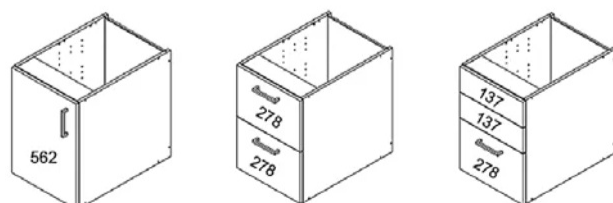

Base cabinets



A



B



BASE OVEN CABINET H. 710, D. 560 MM

Code	Description	NLK
A6U	BASE OVEN CABINET 710*600*560	3020

Plinth legs are not included in the frame package.

- The cabinet has drillings for a Uniset 53 * 500 metal drawer and a Ten baking sheet drawer equipped with a soft-close damper.
- The recommended front panel size is 100 * 596 mm
- NOTE!** The customer must observe the appliance manufacturer's recommendations for installation dimensions and thereby the compatibility of the appliances with the frames.
- For worktops under 30 mm, it is recommended to use option B without an oven drawer to ensure adequate air circulation (verify distances with the appliance supplier)

The free space reserved for the built-in oven can be varied with the installation height of the fixed intermediate shelf

- Intermediate shelf at the lowest, free space 635 mm
- Intermediate shelf at the highest, free space 585 mm (With oven drawer)
- Without intermediate shelf, free space 676 mm

BAKING SHEET DRAWERS

Code	Description	NLK
M60	UNISET LOW 53/500 M60	0253
TENUUNI60	TEN BAKING SHEET DRAWER WITH DAMPER	0338

Drawers are delivered pre-assembled and individually packed in cardboard boxes

Baking sheet drawers see page 20

BASE COMPARTMENT CABINET H. 710, W. 150, D. 560 MM

Code	Description	NLK
A15	SHELF CABINET 710*150*560	3020

Plinth legs are not included in the frame package.

- Possible to use without fixed intermediate shelves (4 pcs)
- Drilling for side-hinged door 100 mm from door ends (Door size 703 x 146)

When using mechanisms, leave the shelves out during cabinet assembly. Install mechanisms before assembling the frame.



VS SUB SLIM 2 shelves: RAL9006, chrome, graphite (Stock product)
VS SUB SLIM shelf + towel rail: RAL9006, chrome, graphite (Stock product)
VS SUB SLIM baking sheet holder: Chrome (Stock product)

See various drawer and mechanism options for base cabinets on pages 20 - 22

Base cabinets



BASE CORNER CABINET H. 710, W. 935, D. 935 MM

Code	Description	NLK
A9X9	BASE CORNER CABINET 710*935*935	3020
AKH9X9	SHELF 895x895x16 WHITE MEL.	3071

Plinth legs and shelves are not included in the frame package.

- The corner cabinet door dimension is 703 * 352 mm
 - - For Fenix doors 703*346 mm
 - - For Synchron/Finger Pull doors 703*348 mm
- Corner cabinet hinge 155° (4 pcs)
- Drilling for side-hinged door 100 mm from door ends
- When using a carousel mechanism, it is recommended to add a screw-mounted plinth leg in the center
- Dimensional drawing on page 10, image 1



VS COR WHEEL PRO

Chrome

Stock product

ANGLED BASE CABINET H. 710, W. 300, D. 560 MM



Code	Description	NLK
A03VINO	ANGLED BASE CABINET 710*300*560	3020

Plinth legs are not included in the frame package.

- The angled base cabinet door dimension is 703 * 396 mm
- Angled base cabinet hinge 45° (2 pcs)
- Drilling for side-hinged door 100 mm from door ends



VS SUB SIDE W45

Chrome

Stock product

The mechanism in the image is right-handed

Base cabinets



ANGLED BASE END SHELF H. 710, W. 300, D. 560 MM

Code	Description	NLK
A03VPHV	ANGLED BASE END SHELF 710*300*560	3020

The frame package includes 2 fixed open shelves

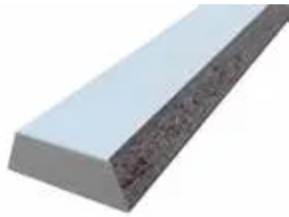

BASE CABINET CONSOLE STRIP

Code	Description	NLK
AKOLV	BASE CABINET C. STRIP 710X31/44X16 WHITE	3077

- Installation strip for corner stove
- See dimensioning under Technical Specifications/Corner cabinet dimensioning stove corner 600 mm



DISHWASHER CABINET H. 1042, W. 632, D. 560 MM

Code	Description	NLK
APK06	DISHWASHER CAB. 1042*632*560	3020

Plinth legs are not included in the frame package.

- Clearance height intended for the dishwasher is 858 mm and width 600 mm
- Integrated dishwasher door dimension is 703 x 596 mm
- Lower drawer has runner mounting holes for a low drawer
- Front panel dimension is 278 x 596 mm
- Drawer and front panel must be ordered separately



COUNTERTOP DRAWER H. 150, D. 560 MM

Code	Description	NLK
TL05	COUNTERTOP DRAWER 150*500*560	3026
TL06	COUNTERTOP DRAWER 150*600*560	3026

- Used under the countertop
- Front panel height 137 mm
- Drillings for low drawers.
- Drillings also work with the ironing board mechanism in the TL05 frame
- For a base solution without holes, an optional accessory B30VA base panel M60 without plinth leg holes is available

Base cabinets

Mechanisms



VS ENVI SPACE WASTE PULL-OUT

- Color RAL9006: widths 400, 450, 500, 600 mm
- Color GRAPHITE: widths 600, 800 mm
- Mechanism with 100% pull-out that follows the door.
- Mechanism with Soft-Close damper
- The steel cover plate of the mechanism also functions as a sliding shelf
- Stock product



VS COR FOLD BLIND CORNER MECHANISM

- Cabinet widths: 900 and 1000 mm
- Door width: 400, 500 mm
- Minimum installation depth: 485 mm
- Minimum installation height: 530 mm
- Individual height adjustment of baskets
- Max load: front baskets 8 kg/basket, rear baskets 9.5 kg/basket
- Load capacity: max. 35 kg
- Stock versions: Saphir and Premea
- The mechanism in the image is right-handed



VS CORNER MAXX BLIND CORNER MECHANISM

- Cabinet width: 1000 mm
- Door width: 500 mm
- Colors: chrome, graphite
- Installation depth: min. 490 mm
- Load capacity: max. 25 kg per shelf
- Stock product
- The mechanism in the image is right-handed



VS CORNER SWING BLIND CORNER MECHANISM

- Cabinet widths: 900 and 1000 mm
- Door widths: 400, 450 and 500 mm
- Optional door mounting
- Soft-close damping
- Stock product

Base cabinets

Drawer options

TEN2 PROFILE DRAWERS WHITE



TEN2 LOW H. 90, D. 500 MM WHITE

Code	Description	NLK
TEN290M30V	ASSEMBLED TEN2 LOW 90/500 M30 WHITE	0360
TEN290M40V	ASSEMBLED TEN2 LOW 90/500 M40 WHITE	0360
TEN290M50V	ASSEMBLED TEN2 LOW 90/500 M50 WHITE	0360
TEN290M60V	ASSEMBLED TEN2 LOW 90/500 M60 WHITE	0360
TEN290M70V	ASSEMBLED TEN2 LOW 90/500 M70 WHITE	0360
TEN290M80V	ASSEMBLED TEN2 LOW 90/500 M80 WHITE	0360
TEN290M90V	ASSEMBLED TEN2 LOW 90/500 M90 WHITE	0360
TEN290M8100V	ASSEMBLED TEN2 LOW 90/500 M100 WHITE	0360
TEN290M8120V	ASSEMBLED TEN2 LOW 90/500 M120 WHITE	0360



TEN2 HIGH H. 180, D. 500 MM WHITE

Code	Description	NLK
TEN2180M30V	ASSEMBLED TEN2 HIGH 180/500 M30 WHITE	0360
TEN2180M40V	ASSEMBLED TEN2 HIGH 180/500 M40 WHITE	0360
TEN2180M50V	ASSEMBLED TEN2 HIGH 180/500 M50 WHITE	0360
TEN2180M60V	ASSEMBLED TEN2 HIGH 180/500 M60 WHITE	0360
TEN2180M70V	ASSEMBLED TEN2 HIGH 180/500 M70 WHITE	0360
TEN2180M80V	ASSEMBLED TEN2 HIGH 180/500 M80 WHITE	0360
TEN2180M90V	ASSEMBLED TEN2 HIGH 180/500 M90 WHITE	0360
TEN2180M8100V	ASSEMBLED TEN2 HIGH 180/500 M100 WHITE	0360
TEN2180M8120V	ASSEMBLED TEN2 HIGH 180/500 M120 WHITE	0360

TEN2 drawer runners load capacity 45 kg/drawer

TEN2 PROFILE DRAWERS ANTHRACITE



TEN2 LOW H. 90, D. 500 MM ANTHRACITE

Code	Description	NLK
TEN290M30H	ASSEMBLED TEN2 LOW 90/500 M30 ANTHR	0361
TEN290M40H	ASSEMBLED TEN2 LOW 90/500 M40 ANTHR	0361
TEN290M50H	ASSEMBLED TEN2 LOW 90/500 M50 ANTHR	0361
TEN290M60H	ASSEMBLED TEN2 LOW 90/500 M60 ANTHR	0361
TEN290M70H	ASSEMBLED TEN2 LOW 90/500 M70 ANTHR	0361
TEN290M80H	ASSEMBLED TEN2 LOW 90/500 M80 ANTHR	0361
TEN290M90H	ASSEMBLED TEN2 LOW 90/500 M90 ANTHR	0361
TEN290M8100H	ASSEMBLED TEN2 LOW 90/500 M100 ANTHR	0361
TEN290M8120H	ASSEMBLED TEN2 LOW 90/500 M120 ANTHR	0361



TEN2 HIGH H. 180, D. 500 MM ANTHRACITE

Code	Description	NLK
TEN2180M30H	ASSEMBLED TEN2 HIGH 180/500 M30 ANTHR	0361
TEN2180M40H	ASSEMBLED TEN2 HIGH 180/500 M40 ANTHR	0361
TEN2180M50H	ASSEMBLED TEN2 HIGH 180/500 M50 ANTHR	0361
TEN2180M60H	ASSEMBLED TEN2 HIGH 180/500 M60 ANTHR	0361
TEN2180M70H	ASSEMBLED TEN2 HIGH 180/500 M70 ANTHR	0361
TEN2180M80H	ASSEMBLED TEN2 HIGH 180/500 M80 ANTHR	0361
TEN2180M90H	ASSEMBLED TEN2 HIGH 180/500 M90 ANTHR	0361
TEN2180M8100H	ASSEMBLED TEN2 HIGH 180/500 M100 ANTHR	0361

TEN2180M8120H ASSEMBLED TEN2 HIGH 180/500 M120 ANTHR 0361

TEN2 drawer runners load capacity 45 kg/drawer

Drawers are delivered pre-assembled and individually packed in cardboard packaging

Base cabinets

Drawer options

TEN2 SINK DRAWER

- Efficient space management under the sink and around the water trap
- Use with a 450 mm deep drawer



TEN2 SINK DRAWER H. 120, D. 450 MM WHITE

Code	Description	NLK
TEN2120M60VAL	TEN2 SINK DR. 120/450 M60 WHITE	0360
TEN2120M70VAL	TEN2 SINK DR. 120/450 M70 WHITE	0360
TEN2120M80VAL	TEN2 SINK DR. 120/450 M80 WHITE	0360



TEN2 SINK DRAWER H. 120, D. 450 MM ANTHRACITE

Code	Description	NLK
TEN2120M60HAL	TEN2 SINK DR. 120/450 M60 ANTHR	0361
TEN2120M70HAL	TEN2 SINK DR. 120/450 M70 ANTHR	0361
TEN2120M80HAL	TEN2 SINK DR. 120/450 M80 ANTHR	0361

TEN2 drawer runners load capacity 45 kg/drawer

UNISET 53 BAKING SHEET DRAWER



ASSEMBLED UNISET OVEN DRAWER

Code	Description	NLK
M60	UNISET LOW 53/500 M60	0253

TEN2 BAKING SHEET DRAWER WITH DAMPER

- Ten baking sheet drawer equipped with a soft-close damper.
- Drawer size 600*450 mm
- The drawer holds more than one sheet
- The A6U frame has pre-drilled fixing holes for the oven drawer runners. The drawer can also be installed in frames from other manufacturers by placing the runners directly on the bottom panel and fixing them with wood screws.



The package includes:

- Oven drawer 1 pc
- TEN runner 450 and damper 45 kg 1 pair
- Necessary screws: 4 pcs Euro screws, 4 pcs wood screws for fixing runners, 2 pcs low-head screws for fixing the sheet to the runner, and 4 pcs front panel fixing screws
- Drawer installation instructions

ASSEMBLED TEN BAKING SHEET DRAWER

Code	Description	NLK
TENUUNI60	TEN BAKING SHEET DRAWER WITH DAMPER	0338

Drawers are delivered pre-assembled and individually packed in cardboard packaging

Base cabinets

Accessories



ALUMINUM PROTECTION PLATE FOR BASE CABINET BOTTOM

Code	Description	NLK
F16003	BASE CABINET PROTECTION PLATE 467*538 M50	3092
F16004	BASE CABINET PROTECTION PLATE 567*538 M60	3092
F16005-ESP	BASE CABINET PROTECTION PLATE 668*538 M70	3092
F16006	BASE CABINET PROTECTION PLATE 767*538 M80	3092
F16008-ESP	BASE CABINET PROTECTION PLATE 968*538 M100	3092



METAL CONNECTING RAIL

Code	Description	NLK
14802	CONNECTING RAIL M40 WHITE	3089
14803	CONNECTING RAIL M50 WHITE	3089
14804	CONNECTING RAIL M60 WHITE	3089
22021	CONNECTING RAIL M70 WHITE	3089
14805	CONNECTING RAIL M80 WHITE	3089
22022	CONNECTING RAIL M90 WHITE	3089
14806	CONNECTING RAIL M100 WHITE	3089



METAL CONNECTING RAIL

Code	Description	NLK
380130400	STOVE PROTECTION RAIL 710x50x1 WHI	3089



Base cabinets

Accessories



TEN2 TOP FRAME WASTE PULL-OUTS & BINS

- Top-mounted sorting mechanism for waste sorting.
- Colors white and anthracite
- Drawer depth 450 mm.
- Drawer components and bins are included in the set.
- Works only in a 16mm frame
- Support arms are available as accessories in both colors.
- Recommended for use with a 703 mm door.



BIN FOR SORTING FRAME ANTHRACITE

Code	Description	NLK
380133803	BIN 5L GREY	0691
380133804	BIN 10L GREY	0691
3801338041	BIN 15L GREY	0691
380133805	BIN 17L GREY	0691
380133806	BIN 21L GREY	0691
380133802	LID FOR 10L BIN GREY	0691



OPTIONS FOR TOP FRAME BINS

M3

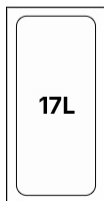

M4

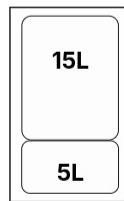
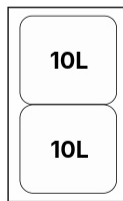
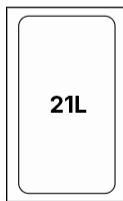

M5

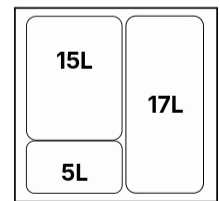
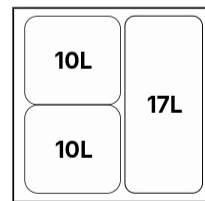
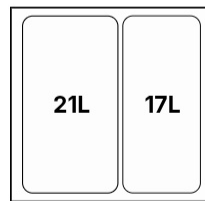

M3 & M4 SETS / TOP-MOUNTED SORTING FRAME

Code	Description	NLK
3804431	T.M. FRAME M3 WHITE 17L	0692
3804441	T.M. FRAME M4 WHITE 21L	0692
3804442	T.M. FRAME M4 WHITE 10L+10L	0692
3804443	T.M. FRAME M4 WHITE 15L+5L	0692
3804431H	T.M. FRAME M3 ANTHRACITE 17L	0692
3804441H	T.M. FRAME M4 ANTHRACITE 21L	0692
3804442H	T.M. FRAME M4 ANTHRACITE 10L+10L	0692
3804443H	T.M. FRAME M4 ANTHRACITE 15L+5L	0692

M5 SETS / TOP-MOUNTED SORTING FRAME

Code	Description	NLK
3804451	T.M. FRAME M5 WHITE 17L+21L	0692
3804452	T.M. FRAME M5 WHITE 17L+10L+10	0692
3804453	T.M. FRAME M5 WHITE 17L+15L+5L	0692
3804451H	T.M. FRAME M5 ANTHRACITE 17L+21L	0692
3804452H	T.M. FRAME M5 ANTHRACITE 17L+10L+10	0692
3804453H	T.M. FRAME M5 ANTHRACITE 17L+15L+5L	0692

Base cabinets

Accessories

M6

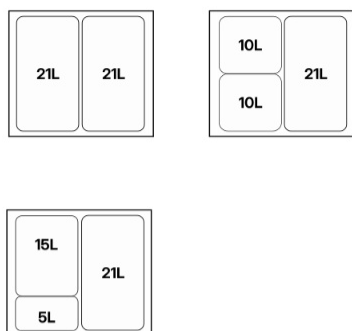

M7

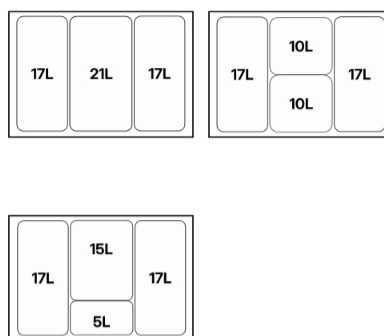

M6 SETS / TOP-MOUNTED SORTING FRAME

Code	Description	NLK
3804461	T.M. FRAME M6 WHITE 21L+21L	0692
3804462	T.M. FRAME M6 WHITE 21L+10L+10	0692
3804463	T.M. FRAME M6 WHITE 21L+15L+5L	0692
3804461H	T.M. FRAME M6 ANTHRACITE 21L+21L	0692
3804462H	T.M. FRAME M6 ANTHRACITE 21L+10L+10	0692
3804463H	T.M. FRAME M6 ANTHRACITE 21L+15L+5L	0692

M7 SETS / TOP-MOUNTED SORTING FRAME

Code	Description	NLK
3804471	T.M. FRAME M7 WHITE 17L+21L+17	0692
3804472	T.M. FRAME M7 WHITE 17+10+10+17	0692
3804473	T.M. FRAME M7 WHITE 17+15+5+17	0692
3804471H	T.M. FRAME M7 ANTHRACITE 17L+21L+17	0692
3804472H	T.M. FRAME M7 ANTHRACITE 17+10+10+17	0692
3804473H	T.M. FRAME M7 ANTHRACITE 17+15+5+17	0692

M8

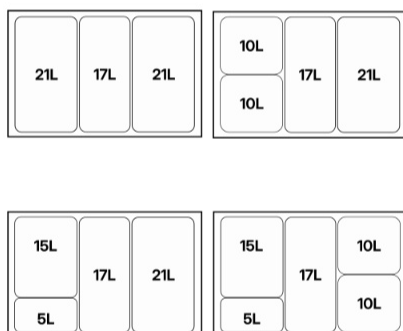

M9

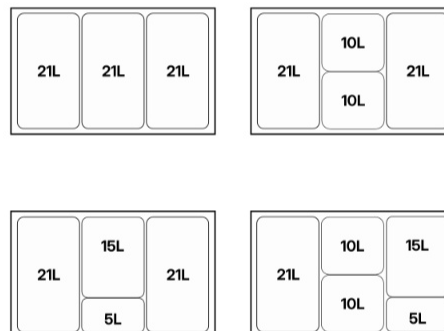

M8 SETS / TOP-MOUNTED SORTING FRAME

Code	Description	NLK
3804481	T.M. FRAME M8 WHITE 21L+17L+21	0692
3804482	T.M. FRAME M8 WHITE 21+17+10+10	0692
3804483	T.M. FRAME M8 WHITE 21+17+15+5	0692
3804484	T.M. FRAME M8 WHITE 10+10+17+15+5	0692
3804481H	T.M. FRAME M8 ANTHRACITE 21L+17L+21	0692
3804482H	T.M. FRAME M8 ANTHRACITE 21+17+10+10	0692
3804483H	T.M. FRAME M8 ANTHRACITE 21+17+15+5	0692
3804484H	T.M. FRAME M8 ANTHRACITE 10+10+17+15+5	0692

M9 SETS / TOP-MOUNTED SORTING FRAME

Code	Description	NLK
3804491	T.M. FRAME M9 WHITE 21L+21L+21	0692
3804492	T.M. FRAME M9 WHITE 21+10+10+21	0692
3804493	T.M. FRAME M9 WHITE 21+15+5+21	0692
3804494	T.M. FRAME M9 WHITE 21+10+10+15+5	0692

M10

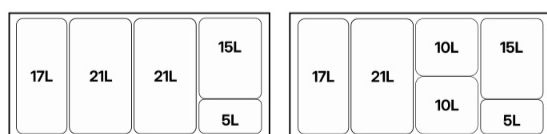

M10 SETS / TOP-MOUNTED SORTING FRAME

Code	Description	NLK
3804501	T.M. FRAME M10 WHITE 17+21+15+5+21	0692
3804502	T.M. FRAME M10 WHITE 17+21+15+5+10+10	0692



SUPPORT ARMS FOR TOP-MOUNTED SORTING FRAME

Code	Description	NLK
3804900	SUPPORT ARMS WITH SCREWS WHITE	0691
3804900A	SUPPORT ARMS WITH SCREWS ANTHRACITE	0691



Wall cabinets

- Heights 988, 704, 565, 450, 352, 284 mm
- Depth 336 mm
- Back panel always grooved in (connecting rails behind the back panel).
- Shelves are included in the 988, 704, and 565 mm high frame packages.
- For other frame sizes, shelves are available as an accessory to order.
- A metal frame is used as an additional product in the drying cabinet.
- In addition to standard sizes, frames are available in custom sizes.
- The made-to-order colors are white, oak, and anthracite.

WALL CABINET STRUCTURE

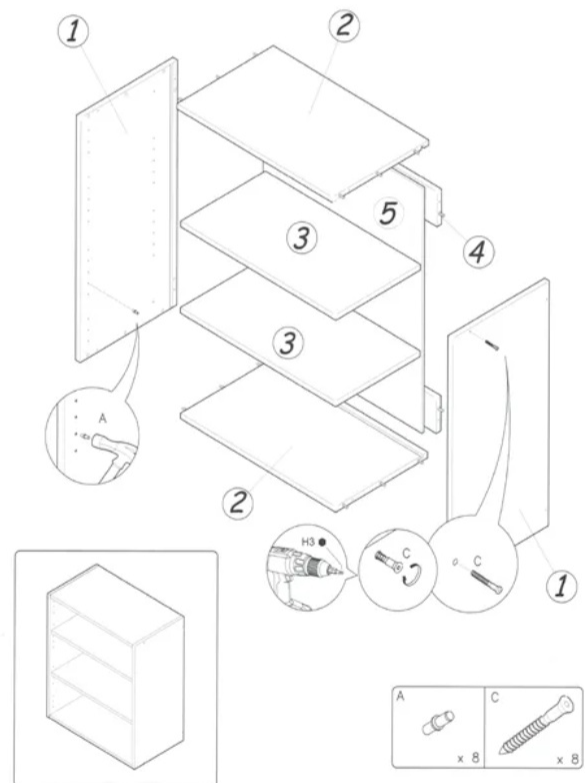

DRYING CABINET STRUCTURE

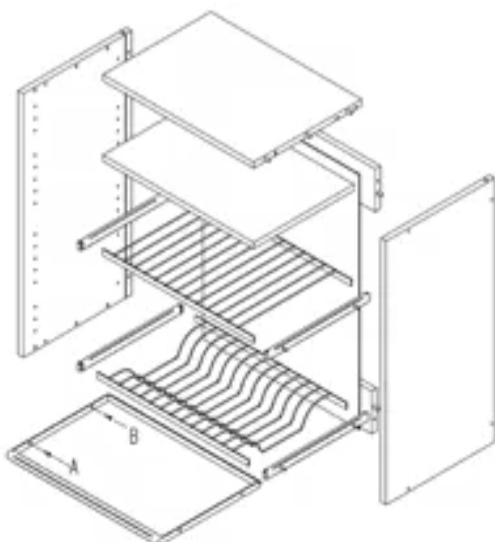

Wall cabinets

High wall cabinets 988 mm



WALL CABINET H. 988, D. 336 MM

Code	Description	NLK
SK03	HIGH WALL CABINET 988*300*336	3038
SK04	HIGH WALL CABINET 988*400*336	3038
SK045	HIGH WALL CABINET 988*450*336	3038
SK05	HIGH WALL CABINET 988*500*336	3038
SK06	HIGH WALL CABINET 988*600*336	3038
SK07	HIGH WALL CABINET 988*700*336	3038
SK08	HIGH WALL CABINET 988*800*336	3038
SK09	HIGH WALL CABINET 988*900*336	3038
SK10	HIGH WALL CABINET 988*1000*336	3038

MOISTURE-RESISTANT (P3)

Code	Description	NLK
SK04KK	HIGH WALL CABINET MR 988*400*336	3032
SK05KK	HIGH WALL CABINET MR 988*500*336	3032
SK06KK	HIGH WALL CABINET MR 988*600*336	3032
SK08KK	HIGH WALL CABINET MR 988*800*336	3032
SK10KK	HIGH WALL CABINET MR 988*1000*336	3032

The frame package includes 3 shelves and shelf supports

Drillings

- Drilling for side-hinged door 100 mm from door ends

NOTE! The depth of the wall cabinets allows for the installation of an integrated microwave. The net depth of the cabinet is 316 mm. The customer must observe the appliance manufacturer's recommendations for installation dimensions and thereby the compatibility of the appliances with the frames.

See adjustable ventilation grilles on page 47 under accessories.

BASE PANEL FOR MICROWAVE OVEN

Code	Description
MH05VA	BASE PANEL FOR MICROWAVE M50 468x380x16 R0 WHITE MEL.
MH06VA	BASE PANEL FOR MICROWAVE M60 568x380x16 R0 WHITE MEL.

- Base panel for non-integrated microwave available as an accessory
- Base panel depth 380 mm (internal dimension 360 mm)
- The height of the door used above is determined by the microwave model
- The base panel is installed in place of the cabinet bottom panel that comes with the frame

EXTRACTOR FAN CABINET H. 845, D. 130 MM

Code	Description	NLK
SK2T5	HIGH EXTRACTOR CAB. 845*500*130	3038
SK2T6	HIGH EXTRACTOR CAB. 845*600*130	3038
144901009F	EXTRACTOR CAB. FRONT PANEL BRACKET 4pcs	2010

The frame package includes 3 fixed shelves

- Drilling for side-hinged door 100 mm from door ends
- Door height 703 mm, with a 137 mm high front as a cover panel
- The package includes 2 separate mounting blocks for the fan.
- **NOTE!** Front panel brackets must be ordered separately



Wall cabinets

High wall cabinets 988 mm



CORNER WALL CABINET H. 988 MM

Code	Description	NLK
SK6X6	HIGH CORNER WALL CAB. 988*635/635*635	3038

The frame package includes 3 shelves and shelf supports

- Drilling for side-hinged door 100 mm from door ends
- The corner cabinet door dimension is 988*396 mm
- Corner cabinet hinge 105° or 155°
- Dimensional drawing on page 10, image 1



L-CORNER WALL CABINET H. 988 MM

Code	Description	NLK
SK6X6L	HIGH L-CORNER WALL CAB. 988*658/658*336	3038

The frame package includes 3 shelves and shelf supports

- Drilling for side-hinged door 100 mm from door ends
- The corner cabinet door dimension is 988*296 mm
- Corner cabinet hinge 155° (4 pcs)
- An optional strip to cover the gap between doors is available:
3804899 L-CORNER CAB. DOOR STRIP 987MM WHITE
- Dimensioning from pages 10 - 11



WALL COMPARTMENT CABINET H. 988, W. 150, D. 336 MM

Code	Description	NLK
SK15LOK	HIGH WALL COMP. CAB. 988*150*336	3038

The frame package includes 4 fixed shelves



WALL CONSOLE H. 988 MM

Code	Description	NLK
SKKONSO	WALL CONSOLE 988 WHITE	3038

The frame package includes 3 fixed shelves

- Used in corner solutions
- Frame sides at a 45-degree angle
- No hinge drillings
- Dimensional drawing on page 10, image 3



ANGLED END SHELF H. 988, W. 300, D. 336 MM

Code	Description	NLK
SK03VPHV	HIGH ANGLED END SHELF 988*300*336	3038

The frame package includes 3 fixed open shelves



Wall cabinets

Low wall cabinets 704 mm



WALL CABINET H. 704, D. 336 MM

Code	Description	NLK
SM03	LOW WALL CABINET 704*300*336	3041
SM04	LOW WALL CABINET 704*400*336	3041
SM045	LOW WALL CABINET 704*450*336	3041
SM05	LOW WALL CABINET 704*500*336	3041
SM06	LOW WALL CABINET 704*600*336	3041
SM07	LOW WALL CABINET 704*700*336	3041
SM08	LOW WALL CABINET 704*800*336	3041
SM09	LOW WALL CABINET 704*900*336	3041
SM10	LOW WALL CABINET 704*1000*336	3041

MOISTURE-RESISTANT (P3)

Code	Description	NLK
SM06KK	LOW WALL CABINET MR 704*600*336	3035
SM08KK	LOW WALL CABINET MR 704*800*336	3035
SM10KK	LOW WALL CABINET MR 704*1000*336	3035

The frame package includes 2 shelves and shelf supports

Drillings

- Drilling for side-hinged door 100 mm from door ends

NOTE! The depth of the wall cabinets allows for the installation of an integrated microwave. The net depth of the cabinet is 316 mm. The customer must observe the appliance manufacturer's recommendations for installation dimensions and thereby the compatibility of the appliances with the frames.

See adjustable ventilation grilles on page 47 under accessories.

BASE PANEL FOR MICROWAVE OVEN

Code	Description
MH05VA	BASE PANEL FOR MICROWAVE M50 468x380x16 R0 WHITE MEL.
MH06VA	BASE PANEL FOR MICROWAVE M60 568x380x16 R0 WHITE MEL.

- Base panel for non-integrated microwave available as an accessory
- Base panel depth 380 mm (internal dimension 360 mm)
- The height of the door used above is determined by the microwave model
- The base panel is installed in place of the cabinet bottom panel that comes with the frame

EXTRACTOR FAN CABINET H. 587, D. 130 MM

Code	Description	NLK
SM2T5	LOW EXTRACTOR CAB. 587*500*130	3041
SM2T6	LOW EXTRACTOR CAB. 587*600*130	3041
144901009F	EXTRACTOR CAB. FRONT PANEL BRACKET 4pcs	2010

The frame package includes 2 fixed shelves

- Drilling for side-hinged door 100 mm from door ends
- Door height 445 mm, with a 137 mm high front as a cover panel
- The package includes 2 separate mounting blocks for the fan.
- **NOTE!** Front panel brackets must be ordered separately



Front panel brackets

Fan mounting blocks

Wall cabinets

Low wall cabinets 704 mm



CORNER WALL CABINET H. 704 MM

Code	Description	NLK
SM6X6	LOW CORNER WALL CAB. 704*635*635	3041

The frame package includes 2 shelves and shelf supports

- Drilling for side-hinged door 100 mm from door ends
- The corner cabinet door dimension is 703*396 mm
- Corner cabinet hinge 105° or 155°
- Dimensional drawing on page 10, image 1



L-CORNER WALL CABINET H. 704 MM

Code	Description	NLK
SM6X6L	LOW L-CORNER WALL CAB. 704*658/658*336	3041

The frame package includes 2 shelves and shelf supports

- Drilling for side-hinged door 100 mm from door ends
- The corner cabinet door dimension is 703*296 mm (2 pcs)
- Corner cabinet hinge 155° (4 pcs)
- An optional strip to cover the gap between doors is available:
3804899 L-CORNER CAB. DOOR STRIP 987MM WHITE
- Dimensioning on pages 10 - 11



WALL COMPARTMENT CABINET H. 704, W. 150, D. 336 MM

Code	Description	NLK
SM15LOK	LOW WALL COMP. CAB. 704*150*336	3041

The frame package includes 3 fixed shelves



ANGLED END SHELF H. 704, W. 300, D. 336 MM

Code	Description	NLK
SM03VPHV	LOW ANGLED END SHELF 704X300X336	3041

The frame package includes 2 fixed open shelves



WALL CONSOLE H. 704 MM

Code	Description	NLK
SMKONSO	LOW WALL CONSOLE 704 WHITE	3041

The frame package includes 2 fixed shelves

- Used in corner solutions
- Frame sides at a 45-degree angle
- No hinge drillings
- Dimensional drawing on page 10, image 2



Wall cabinets

Low wall cabinets 704 mm



WALL CABINET H. 565, D. 336 MM

Code	Description	NLK
SMM04	LOW WALL CABINET 565*400*336	3044
SMM05	LOW WALL CABINET 565*500*336	3044
SMM06	LOW WALL CABINET 565*600*336	3044
SMM08	LOW WALL CABINET 565*800*336	3044

The frame package includes 1 shelf and shelf supports

- Drilling for side-hinged door 100 mm from door ends
- Drilling for top-hinged door 100 mm from door ends



WALL CABINET H. 450, D. 336 MM

Code	Description	NLK
SME04	LOW WALL CABINET 450*400*336	3047
SME05	LOW WALL CABINET 450*500*336	3047
SME06	LOW WALL CABINET 450*600*336	3047
SME08	LOW WALL CABINET 450*800*336	3047

Shelves are not included in the frame package.

- Drilling for side-hinged door 100 mm from door ends
- Drilling for top-hinged door 100 mm from door ends



WALL CABINET H. 352, D. 336 MM

Code	Description	NLK
SYM04	LOW WALL CABINET 352*400*336	3050
SYM05	LOW WALL CABINET 352*500*336	3050
SYM06	LOW WALL CABINET 352*600*336	3050
SYM08	LOW WALL CABINET 352*800*336	3050
SYM10	LOW WALL CABINET 352*1000*336	3050

Shelves are not included in the frame package.

- Drilling for side-hinged door 75 mm from door ends
- Drilling for top-hinged door 100 mm from door ends



WALL CABINET H. 284, D. 336 MM

Code	Description	NLK
SYMHR04	LOW WALL CABINET 284*400*336	3053
SYMHR05	LOW WALL CABINET 284*500*336	3053
SYMHR06	LOW WALL CABINET 284*600*336	3053
SYMHR08	LOW WALL CABINET 284*800*336	3053

Shelves are not included in the frame package.

- Drilling for side-hinged door 55 mm from door ends
- Drilling for top-hinged door 100 mm from door ends



LIGHT BOTTOM

Code	Description	NLK
VAP03V	LIGHT BOTTOM M30	3080
VAP04V	LIGHT BOTTOM M40	3080
VAP045V	LIGHT BOTTOM M45	3080
VAP05V	LIGHT BOTTOM M50	3080
VAP06V	LIGHT BOTTOM M60	3080
VAP07V	LIGHT BOTTOM M70	3080
VAP08V	LIGHT BOTTOM M80	3080
VAP09V	LIGHT BOTTOM M90	3080
VAP10V	LIGHT BOTTOM M100	3080
VAPKKL	LIGHT BOTTOM SK&SM 6X6L	3080
VAPKKV	LIGHT BOTTOM SK&SM 6X6	3080

The delivery includes only the light bottom panel with spot cutouts. The diameter of the cutouts is 58 mm and they fit all spotlights in our selection.

In addition to the light bottom panel, the following lighting components must also be ordered:

- M30 - M45: 1 lamp
- M50 - M70: 2 lamps
- M80 - M100: 3 lamps
- corner cabinet light bottom panel: 4 lamps
- driver

LIGHT BOTTOMS WITH LED LIGHTS

Code	Description	NLK
VAPLEDEM03V	LIGHT BOTTOM M30 + 1 LED EM.	3080
VAPLEDEM04V	LIGHT BOTTOM M40 + 1 LED EM.	3080
VAPLEDEM045V	LIGHT BOTTOM M45 + 1 LED EM.	3080
VAPLEDEM05V	LIGHT BOTTOM M50 + 1 LED EM.	3080
VAPLEDEM06V	LIGHT BOTTOM M60 + 1 LED EM.	3080
VAPLEDEM07V	LIGHT BOTTOM M70 + 2 LED EM.	3080
VAPLEDEM08V	LIGHT BOTTOM M80 + 2 LED EM.	3080
VAPLEDEM09V	LIGHT BOTTOM M90 + 2 LED EM.	3080
VAPLEDEM10V	LIGHT BOTTOM M100 + 3 LED EM.	3080
VAPLEDEMKKL	LIGHT BOTTOM SK&SM6X6L + 3 LED EM.	3080
VAPLEDEMKKV	LIGHT BOTTOM SK&SM6X6 + 3 LED EM.	3080

The number of spot holes in the products corresponds to the description, and the delivery includes LED Chip Emotion spots, which are pre-installed in the light bottom panel.

LED CHIP 58EMOTION 12V, 4W

- Luminous flux 250lm
- Light tone Emotion 2700-6500K
- Color stainless steel look
- IP rating IP20
- 1.8 m cable with quick connector



DRIVERS IP44 (MUST BE ORDERED SEPARATELY)

Code	Description	NLK
5990428-10	LED DRIVER 30W 12V IP44 10-PIN	1007
3026621-10	LED DRIVER 60W 12V IP20 12-PIN	1007
4709866-10	LED DRIVER 60W 12V STU RECEIVER 12-PIN	1007
2000388	STU SWITCH EMOTION SURFACE MOUNT	1005
2000390	STU SWITCH EMOTION 4-CHANNEL	1005



Wall cabinets

Accessories



WALL CABINET BOTTOM PANELS WITH FINGER PULL

Code	Description	NLK
BYL03	WALL CAB. BOTTOM PANEL BYL03 268*315 M3	3102
BYL04	WALL CAB. BOTTOM PANEL BYL04 368*315 M4	3102
BYL045	WALL CAB. BOTTOM PANEL BYL045 418*315 M45	3102
BYL05	WALL CAB. BOTTOM PANEL BYL05 468*315 M5	3102
BYL06	WALL CAB. BOTTOM PANEL BYL06 568*315 M6	3102
BYL07	WALL CAB. BOTTOM PANEL BYL07 668*315 M7	3102
BYL08	WALL CAB. BOTTOM PANEL BYL08 768*315 M8	3102
BYL09	WALL CAB. BOTTOM PANEL BYL09 868*315 M9	3102
BYL10	WALL CAB. BOTTOM PANEL BYL10 968*315 M10	3102
BYL6X6L	WALL CAB. BOTTOM PANEL BYL6X6L 642X642	3102

- Wall cabinet bottom panel with finger pull for wall cabinets with a handleless solution.



ALUMINUM PROTECTION PLATE FOR WALL CABINET BOTTOM

Code	Description	NLK
F160011	WALL CABINET PROTECTION PLATE 367*314 M40	3092
F160031	WALL CABINET PROTECTION PLATE 467*314 M50	3092
F160041	WALL CABINET PROTECTION PLATE 567*314 M60	3092
F160061	WALL CABINET PROTECTION PLATE 767*314 M80	3092
F160081	WALL CABINET PROTECTION PLATE 967*314 M100	3092



DRYING CABINET WIRE SHELF SET

Code	Description	NLK
5658510036000	SHELF+PLATE RACK+DRIP TRAY M4 SST	0682
5658510041000	SHELF+PLATE RACK+DRIP TRAY M4.5 SST	0682
5658510046000	SHELF+PLATE RACK+DRIP TRAY M5 SST	0682
5658510056000	SHELF+PLATE RACK+DRIP TRAY M6 SST	0682
5658510076000	SHELF+PLATE RACK+DRIP TRAY M8 SST	0682
5658510096000	SHELF+PLATE RACK+DRIP TRAY M10 SST	0682

- Fixing pin spacing 224/5 mm hole



GLASS SHELF D. 275 MM

Code	Description	NLK
LASH03	GLASS SHELF CLEAR 266*275*6	1951
LASH04	GLASS SHELF CLEAR 366*275*6	1951
LASH05	GLASS SHELF CLEAR 466*275*6	1951
LASH06	GLASS SHELF CLEAR 566*275*6	1951
LASH08	GLASS SHELF CLEAR 766*275*6	1951
LASH10	GLASS SHELF CLEAR 966*275*8	1951

GLASS SHELF D. 310 MM (FOR CC FRAMES)

Code	Description	NLK
LASIH03	GLASS SHELF CLEAR 266*310*6 mm	1952
LASIH04	GLASS SHELF CLEAR 366*310*6 mm	1952
LASIH05	GLASS SHELF CLEAR 466*310*6 mm	1952
LASIH06	GLASS SHELF CLEAR 566*310*6 mm	1952
LASIH08	GLASS SHELF CLEAR 766*310*6 mm	1952
LASIH10	GLASS SHELF CLEAR 966*310*8 mm	1952

- Shelves in cardboard packaging
- The package includes 1 pc shelf + 4 pcs glass shelf supports

Wall cabinets

Accessories



DRYING CABINET FRAME

Code	Description	NLK
14452	FRAME M40 WHITE	3086
12354	FRAME M50 WHITE	3086
12379	FRAME M60 WHITE	3086
22019	FRAME M70 WHITE	3086
12381	FRAME M80 WHITE	3086
22020	FRAME M90 WHITE	3086
12737	FRAME M1000 WHITE	3086

- Installed in place of the cabinet bottom panel.



DRYING CABINET FRAME WITH FINGER PULL

Code	Description	NLK
38775BYL	WALL CABINET FRAME M40 BYL WHITE	3086
38686BYL	WALL CABINET FRAME M50 BYL WHITE	3086
38687BYL	WALL CABINET FRAME M60 BYL WHITE	3086
38776BYL	WALL CABINET FRAME M70 BYL WHITE	3086
38688BYL	WALL CABINET FRAME M80 BYL WHITE	3086
38777BYL	WALL CABINET FRAME M90 BYL WHITE	3086
38689BYL	WALL CABINET FRAME M100 BYL WHITE	3086

- Drying cabinet bottom panel with finger pull for wall cabinets with a handleless solution.
- Installed in place of the cabinet bottom panel.
- 2 x 4*16 mm screws and 2 x 6.3*11 mm Euro screws are needed for fixing.

WALL CABINET LIFT MECHANISMS



D-LITE

- **A1**/frames SYMHR04 - 08, SYM04 - 06
- **B1**/frames SYM08, SME04 - 05
- **C1**/frames SME06 - 08
- Silent and smooth movement without separate hinges
- The mechanism allows partial opening
- Fully mechanical structure
- Easy adjustability



AERO LIFT

- Frames: SMM 562 mm, SME 450 mm & SYM 352 mm
- Compact and reliable solution that is easy to install and use
- Opening angle adjustable to 75°, 90° and 110°
- Fits drillings with 32 mm spacing
- Swings the door upwards
- Hinges can be equipped with a Soft Close damper to achieve smooth closing



AERO WING

- Frames: SYM 352 mm & SYMHR 284 mm
- Versatile: locks in different angular positions, locks the door in the upper position, also for downward-opening doors
- Opening angle adjustable to 75°, 90° or 110°
- Fits frame drillings with 32 mm spacing
- Strong and reliable
- Hinges can be equipped with a Soft Close damper



**KKK FRAME (2202 MM)
DOOR OPTIONS WITH STANDARD
DIMENSIONS**

Door height: 2200 mm

Door drilling:

- 100/8 (with 4 hinges)
- no handedness

Door height: 1920 + 278 mm

Door drilling:

- 1920 mm: 100/8 (with 3 hinges)
- 278 mm: top-hinged 100/8 or side-hinged 55/8

Door height: 1750 + 445 mm

Door drilling:

- 1750 mm: 100/8 (with 3 hinges)
- 445 mm: top-hinged 100/8 or side-hinged 100/8

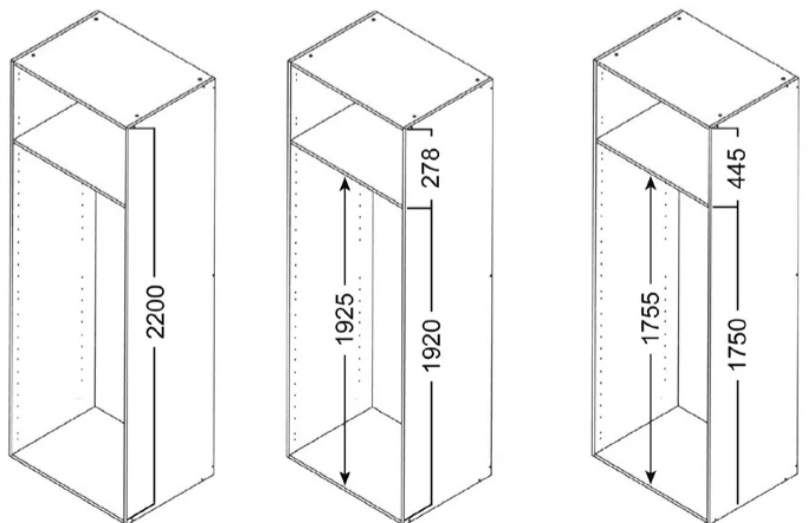

Movable shelf with connecting fittings, suitable for any desired height.



Tall cabinets

- Heights 2202, 1922 and 1750 mm
- Depth 560 mm
- Back panel always grooved in
- Shelves and plinth legs available as accessories to order.
- In addition to standard sizes, frames are available in custom sizes and colors. The made-to-order frame colors are white, oak, and anthracite.



Tall cabinets



**KKK TALL
CABINET 2202
MM**



**KK TALL
CABINET 1922
MM**



**MK TALL
CABINET 1750
MM**

KKK HIGH TALL CABINET H. 2202, D. 560 MM

Code	Description	NLK
KKK03	TALL CABINET 2202*300*560	3056
KKK04	TALL CABINET 2202*400*560	3056
KKK05	TALL CABINET 2202*500*560	3056
KKK06	TALL CABINET 2202*600*560	3056
KKK08	TALL CABINET 2202*800*560	3056
KKK10	TALL CABINET 2202*1000*560	3056
KKK12	TALL CABINET 2202*1200*560	3056

1 fixed shelf. Plinth legs are not included in the frame package.

- The position of the fixed shelf can be chosen at 64 mm intervals. The shelf is locked with the connecting fittings included in the package.

KK HIGH TALL CABINET H. 1922, D. 560 MM

Code	Description	NLK
KK02	HIGH TALL CAB. 1922*200*560	3059
KK03	HIGH TALL CAB. 1922*300*560	3059
KK04	HIGH TALL CAB. 1922*400*560	3059
KK05	HIGH TALL CAB. 1922*500*560	3059
KK06	HIGH TALL CAB. 1922*600*560	3059
KK08	HIGH TALL CAB. 1922*800*560	3059
KK10	HIGH TALL CAB. 1922*1000*560	3059
KK12	HIGH TALL CAB. 1922*1200*560	3059

Plinth legs and shelves are not included in the frame package.

MK TALL CABINET H. 1750, D. 560 MM

Code	Description	NLK
MK04	TALL CABINET 1750*400*560	3062
MK05	TALL CABINET 1750*500*560	3062
MK06	TALL CABINET 1750*600*560	3062
MK08	TALL CABINET 1750*800*560	3062
MK10	TALL CABINET 1750*1000*560	3062
MK12	TALL CABINET 1750*1200*560	3062

Plinth legs and shelves are not included in the frame package.

Tall cabinets

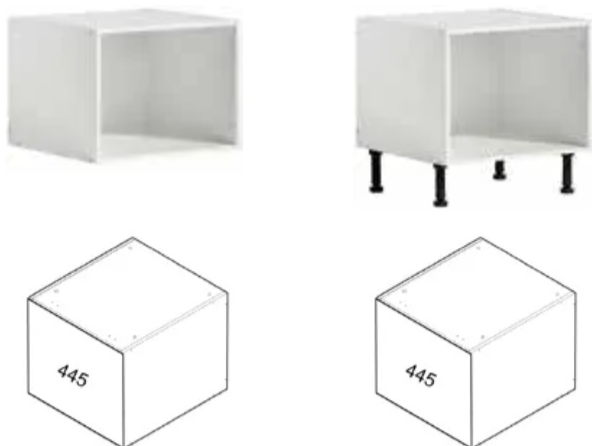

TOP TALL CABINET H. 450, D. 560 MM

Code	Description	NLK
KY04	TOP TALL CABINET 450*400*560	3065
KY05	TOP TALL CABINET 450*500*560	3065
KY06	TOP TALL CABINET 450*600*560	3065
KY08	TOP TALL CABINET 450*800*560	3065
KY10	TOP TALL CABINET 450*1000*560	3065
KY12	TOP TALL CABINET 450*1200*560	3065

Plinth legs and shelves are not included in the frame package.

- The bottom of the frames is prepared for attaching plinth legs, allowing them to be used as base cabinets.
- The frame has drillings for drawer runners:
 - 1 x high with 445 mm front
 - 1 x Top-mounted waste mechanism with 445 mm front
 - Drilling for side-hinged and top-hinged doors 100 mm from the door ends

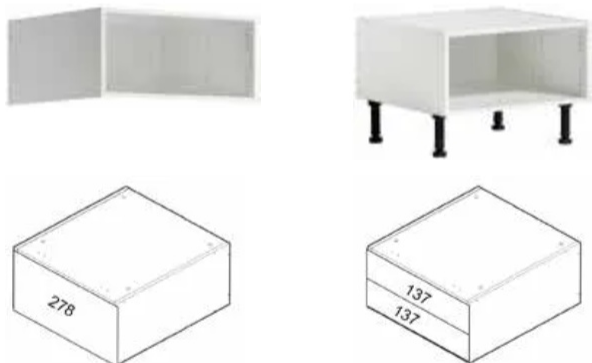

LOW TOP TALL CABINET H. 280, D. 560 MM

Code	Description	NLK
KYM03	TOP TALL CABINET 280*300*560	3068
KYM04	TOP TALL CABINET 280*400*560	3068
KYM05	TOP TALL CABINET 280*500*560	3068
KYM06	TOP TALL CABINET 280*600*560	3068
KYM08	TOP TALL CABINET 280*800*560	3068
KYM10	TOP TALL CABINET 280*1000*560	3068

Plinth legs and shelves are not included in the frame package.

- The bottom of the frames is prepared for attaching plinth legs, allowing them to be used as base cabinets.
- The frame has drillings for drawer runners:
 - 1 x high with 278 mm front
 - 2 x low with 137 mm front
 - 1 x Uniset with 278 mm front
 - Drilling for side-hinged door 55 mm from door ends
 - Drilling for top-hinged door 100 mm from door ends

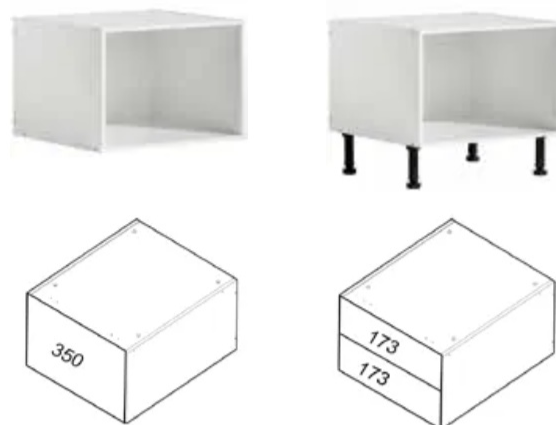

TOP TALL CABINET H. 352, D. 560 MM

Code	Description	NLK
KYMM03	TOP TALL CABINET 352*300*560	3066
KYMM04	TOP TALL CABINET 352*400*560	3066
KYMM05	TOP TALL CABINET 352*500*560	3066
KYMM06	TOP TALL CABINET 352*600*560	3066
KYMM08	TOP TALL CABINET 352*800*560	3066
KYMM10	TOP TALL CABINET 352*1000*560	3066

Plinth legs and shelves are not included in the frame package.

- The bottom of the frames is prepared for attaching plinth legs, allowing them to be used as base cabinets.
- The frame has drillings for drawer runners:
 - 1 x high with 350 mm front
 - 2 x low with 173 mm front
 - Drilling for side-hinged door 55 mm from door ends
 - Drilling for top-hinged door 100 mm from door ends



COUNTERTOP DRAWER H. 150, D. 560 MM

Code	Description	NLK
TL05	COUNTERTOP DRAWER 150*500*560	3026
TL06	COUNTERTOP DRAWER 150*600*560	3026
B30VA	BASE PANEL M60 568x559 NO PLINTH LEG HOLES	3026

Used under the countertop

- Front height 137 mm
- Drillings for drawers:
 - low with 137 mm front
 - Uniset low with 137 mm front
- The drillings also work with the ironing board mechanism in the TL05 frame
- For a base solution without holes, the accessory B30VA base panel M60 without plinth leg holes is available

Tall cabinets

Mechanisms



VS TAL LARDER TALL CABINET MECHANISM

- Cabinet widths: 300, 400 and 500 mm
- Installation depth: 500 mm
- Installation height:
 - - 1200 - 1450 mm (4 baskets)
 - - 1700 - 1950 mm (5 baskets)
- EasyFit: self-locking system for installing the frame without tools
- 3D front adjustment enables simple and convenient front adjustment
- Front stabilization
- Individual height adjustment for baskets
- Durable, quiet roller guides
- Synchronized top and bottom stops
- Fully synchronized bottom frame
- Optional power-assisted movement in the pull-out direction
- Self-closing and soft-closing
- Load capacity: max. 80 kg
- Total load capacity: max. 120 kg
- Stock versions: Saphir, Premea, Artline and Planero



VS TAL GATE TALL CABINET MECHANISM

- Cabinet widths: 500 and 600 mm
- Minimum installation depth: 480 mm
- Installation height: 1700 - 1950 mm (5 baskets)
- EasyFit: tool-free frame installation on the lower runners
- EasyFit: tool-free attachment of the rack to the mounting frame
- Individual height adjustment of the baskets
- Load capacity: max 75 kg
- Stocked versions: Saphir, Premea, Artline, and Planero

Tall cabinets

Mechanisms

VS TAL SLIM TALL CABINET MECHANISM

- Cabinet width: 150 mm
- Installation depth: min. 500 mm
- Installation height: min. 1780 mm
- Optimal air circulation
- Brings the contents to the front of the cabinet
- Front shelf with front connection
- Load capacity: max. 25 kg
- Stock versions: 5 shelves or wine bottle rack for 16 bottles



VS TAL BROOM TALL CABINET MECHANISM

- Cabinet width: 150, 200 mm
- Installation depth: min. 500 mm
- Installation height: min. 1780 mm
- Load capacity: max. 25 kg
- Five shelves with non-adjustable height
- Four 1.2 liter loose containers
- Max. length of broom handle etc. 1380 mm
- Optimal air circulation
- Space-saving mechanism where items are neatly out of sight but easily accessible
- Color: graphite



Tall cabinets

Appliance cabinet for integrated home appliances



APPLIANCE CABINET H. 1922, W. 600, D. 560 MM

Code	Description	NLK
KK6UM	HIGH APPLIANCE CABINET 1922*600*560	3059

The frame package includes 3 shelves. Plinth legs are not included in the frame package.

Shelf connecting fittings:



NOTE! The customer must observe the appliance manufacturer's recommendations for installation dimensions and thereby the compatibility of the appliances with the frames.

LOW TOP APPLIANCE CABINET H. 280, W. 600, D. 560 MM

Code	Description	NLK
KYM6UM	TOP APPLIANCE CABINET 280*600*560	3068

- Mainly used as a top unit above an appliance cabinet to reach a height of 2362 mm
- Ventilation gap behind the back panel (does not include connecting rail)
- Drilling for side-hinged door 55 mm from door ends
- Drilling for top-hinged door 100 mm from door ends
- D-Lite drillings



Tall cabinets

Appliance cabinet for integrated home appliances



**INTEGRATED 1-DOOR
FRIDGE/FREEZER**

- door 1920*596
- no hinge drilling, verify appliance-specific information

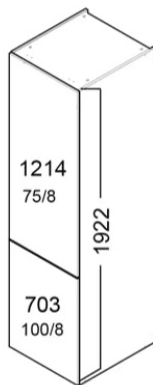

INTEGRATED FRIDGE/FREEZER

- door hinge drillings must be verified appliance-specifically

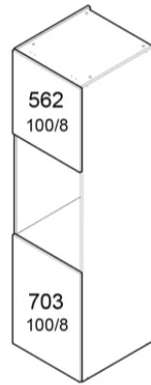

INTEGRATED OVEN

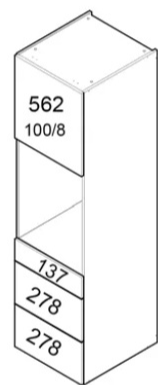

OVEN WITH 3 DRAWERS

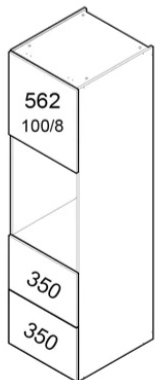

OVEN WITH 2 DRAWERS

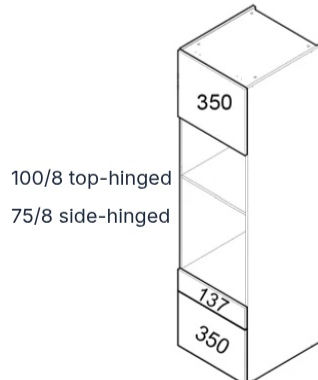

MICROWAVE OVEN + OVEN 2 DRAWERS

55/8 side-hinged from top
148/8 side-hinged from bottom

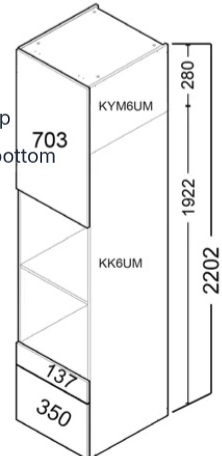

KK6UM + KYM6UM WITH 703 MM DOOR



MADE-TO-ORDER FRAMES

- In addition to standard size frames, custom-sized frames are available to order.
- The made-to-order frame colors are white, anthracite, and oak.
- Material 16 mm melamine-faced chipboard.
- The board's quality classification is E1.
- Back panel is 3.2 mm thick HDF board. The surface color of the back panel matches the frame color.
- All visible edges are banded with 0.8 mm thick ABS edge banding.
- Mounting holes for mechanisms are pre-drilled in the side panels.
- Cabinet frame assembly with wooden dowels and assembly screws. Assembly does not require the use of glue.
- Delivery time 5 weeks from order



MADE-TO-ORDER FRAMES



White



Oak

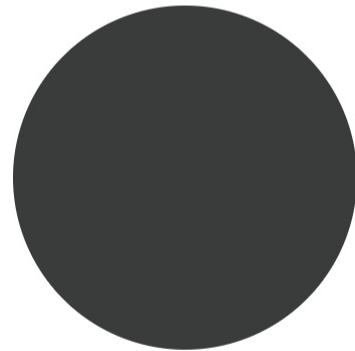

Anthracite

PRICES: STANDARD DIMENSIONS

Description	NLK
ANTHRACITE CABINETS	3104
OAK CABINETS	3105

PRICES: CUSTOM DIMENSIONS

Description	NLK
CUSTOM-SIZED CABINETS	3106
CUSTOM-SIZED ANTHRACITE	3107
CUSTOM-SIZED OAK	3108

Made-to-order frames



BASE CABINETS

Description	Code	Height mm	Width mm	Depth mm
Base cabinet	A_PR	451 - 710	200 - 1200	336 - 560
Base corner cabinet	A9X9	451 - 710	935/935	560

Plinth legs and shelves are not included in the frame package.



WALL CABINETS

Description	Code	Height mm	Width mm	Depth mm
High wall cabinet	SK	705 - 988	151 - 1000	170 - 336
High extractor fan cabinet	SK2T	588 - 845	400 - 600	100
High corner wall cabinet	SK6X6	705 - 988	635/635	336
High L-corner wall cabinet	SK6X6L	705 - 988	658/658	336
Low wall cabinet	SM	566 - 704	151 - 1000	170 - 336
Low extractor fan cabinet	SM2T	491 - 587	400 - 600	100
Low corner wall cabinet	SM6X6	566 - 704	635/635	336
Low L-corner wall cabinet	SM6X6L	566 - 704	658/658	336
Low wall cabinet	SYMHR	284	151 - 800	170 - 336
Low wall cabinet	SYM	285 - 352	151 - 1000	170 - 336
Low wall cabinet	SME	353 - 450	151 - 800	170 - 336
Low wall cabinet	SMM	451 - 565	151 - 800	170 - 336

Shelves are included in 451 - 988 mm high frame packages. For other frame sizes, shelves are available as accessories to order.

TALL CABINETS

Description	Code	Height mm	Width mm	Depth mm
Tall cabinet	MK	711 - 1750	200 - 1200	336 - 560
High tall cabinet	KK	1751 - 1922	200 - 1200	336 - 560
Tall cabinet	KKK	1923 - 2202	300 - 1001	336 - 560
Top cabinet	KYM	280	201 - 1000	337 - 560
Top cabinet	KYMM	281 - 352	201 - 1000	337 - 560
Top cabinet	KY	353 - 450	201 - 1200	337 - 560
Shelf	AKH	16	100 - 1165	100 - 538

1 fixed shelf is included in 1923 - 2202 mm high frame packages. For other frame sizes, shelves are available as accessories to order.

Accessories

PLASTIC PLINTH PANELS

- The plastic structure of the plinth panel guarantees water resistance.
- Available surfaces: aluminum, stainless steel look, matte white, gloss white, black
- Integrated bottom seal.

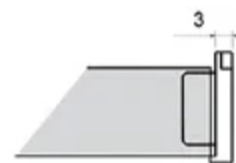
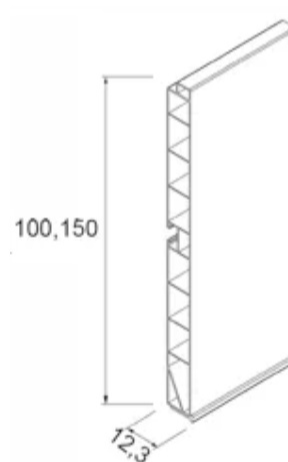
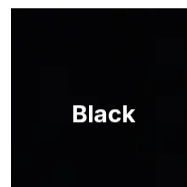
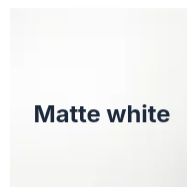
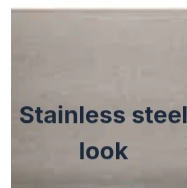

End piece 125

COATED PLINTH PANEL

Code	Description	NLK
101180807	PLINTH PANEL 180 2500/H150 ALUM.	3082
101180813	PLINTH PANEL 180 2500/H150 SST	3082
1011808130	PLINTH PANEL 180 2500/H100 SST	3082
150062250	PLINTH PANEL 180 2500/H150 MATTE WHITE	3082
150064250	PLINTH PANEL 180 2500/H150 GLOSS WHITE	3082
1011808098	PLINTH PANEL 180 2500/H150 BLACK	3082

PLINTH PANEL END PIECE

Code	Description	NLK
101125000	END PIECE 125 H150 GREY	3082

Accessories

Plinths

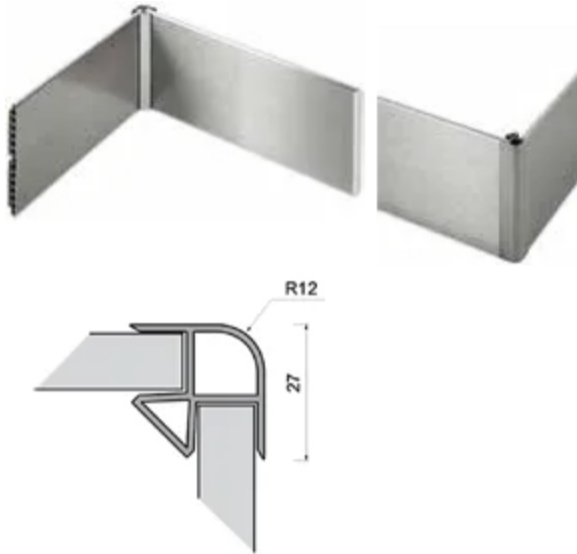

CORNER PIECE 90° & 270°

Code	Description	NLK
101127807	CORNER PIECE 127 90/270 H150 ALUM	3082
101127813	CORNER PIECE 127 90/270 H150 SST	3082
1011308130	CORNER PIECE 127 90/270 H100 SST	3082
147062000	CORNER PIECE 127 90/270 H150 MATTE WHITE	3082
147064000	CORNER PIECE 127 90/270 H150 GLOSS WHITE	3082
147064098	CORNER PIECE 127 90/270 H150 BLACK	3082

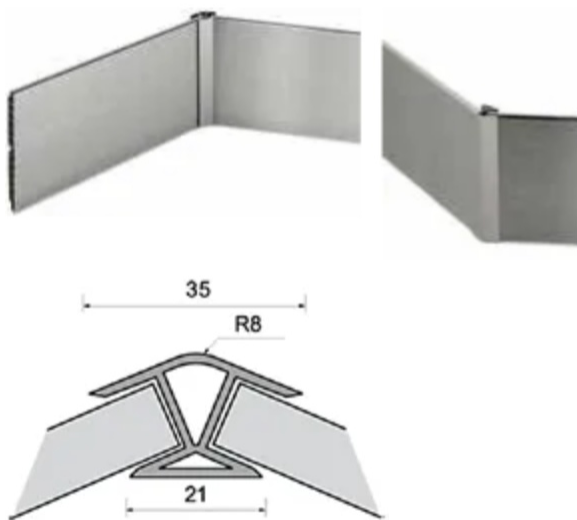

CORNER PIECE 45° & 135°

Code	Description	NLK
101130807	CORNER PIECE 130 45/135 H150 ALUM	3082
101130813	CORNER PIECE 130 45/135 H150 SST	3082
10113081301	CORNER PIECE 130 45/135 H100 SST	3082
147062001	CORNER PIECE 130 45/135 H150 MATTE WHITE	3082
147064001	CORNER PIECE 130 45/135 H150 GLOSS WHITE	3082
147098001	CORNER PIECE 130 45/135 H150 BLACK	3082



PLINTH PANEL EXTENSION PROFILE

Code	Description	NLK
101134807	EXTENSION PROFILE 134 H150 ALUM.	3082
101134813	EXTENSION PROFILE 134 H150 SST	3082
1011348130	EXTENSION PROFILE 134 H100 SST	3082
147062002	EXTENSION PROFILE 134 H150 MATTE WHITE	3082
147064002	EXTENSION PROFILE 134 H150 GLOSS WHITE	3082
1011348098	EXTENSION PROFILE 134 H150 BLACK	3082



VENTILATION GRILLE FOR PLINTH

Code	Description	NLK
323055	VENTILATION GRILLE 500*86 SST	0750
328666	VENTILATION GRILLE 500*86 WHITE	0750
331458	VENTILATION GRILLE 500*86 BLACK	0750
35247380ALU	VENTILATION GRILLE 500*86 ALUM.	0750

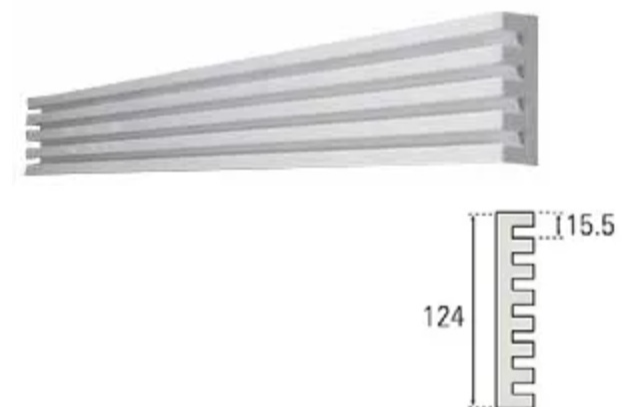

- Material: plastic/aluminum
- The height of the grille can be adjusted by removing slats

ADJUSTABLE VENTILATION GRILLE

Code	Description	NLK
PF22001	VENTILATION GRILLE WHITE ADJ. M60	0750
PF22001-50	VENTILATION GRILLE WHITE ADJ. M50	0750
PF22002	VENTILATION GRILLE BLACK ADJ. M60	0750
PF22006	VENTILATION GRILLE SST ADJ. M60	0750
PF22006-50	VENTILATION GRILLE SST ADJ. M50	0750

Accessories

Melamine parts



MELAMINE COVER PANELS

Code	Description	NLK
KKIS2362VA	COVER PANEL 2362x580x16 WHITE	3041
KKIS2082VA	COVER PANEL 2082x580x16 WHITE	3041
SKIS988V	COVER PANEL 988x356x16 WHITE	3041
ABIS870VA	* BAR BACK PANEL 870x1800x16 WHITE	3041
AIS870VA	COVER PANEL 870x580x16 WHITE	3041
PLPK710VA	* COVER PANEL 710x600x16 WHITE	3041
SMIS704V	COVER PANEL 704x356x16 WHITE	3041
LKISV	COVER PANEL 2730x660x16 WHITE	3074

- Cover panels are edge-banded on three sides: 1 long side, 2 ends.
- * Edge-banded all around

MOISTURE-RESISTANT MELAMINE COVER PANELS

Code	Description	NLK
KKIS2362VAK	TALL CABINET COVER PANEL 2362x580x16 MR	3098
SKISVA-K	COVER PANEL MR 988x336x16 WHITE	3074
AISVA-K	COVER PANEL MR 710x560x16 WHITE	3074
SMISVA-K	COVER PANEL MR 704x336x16 WHITE	3074

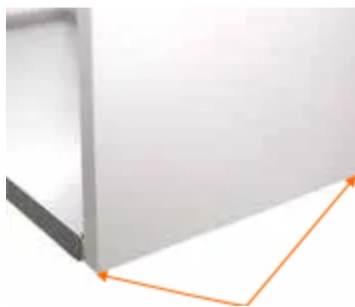

NOTE! Panel attachment with wooden dowels and glue, no holes for assembly screws.

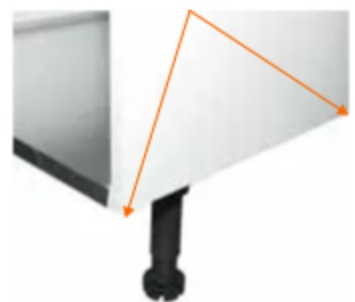

MELAMINE PLINTHS

Code	Description	NLK
SOK23VA	PLINTH 2362X155X16 WHITE	3083
SOK23VA2	TOP FILLER 2362X250X16 WHITE	3083

- The length of the melamine plinths is 2362 mm
- The 2362 mm dimension is the same as for the cover panel and can also be used e.g. as a side filler



BOTTOM PROFILE FOR MELAMINE PLINTH

Code	Description	NLK
F24020	PLINTH BOTTOM PROF. for 16 mm board 3600MM CLEAR	3083
F24021	PLINTH BOTTOM PROF. for 18-19 mm board 3600MM CLEAR	3083



CORNER PROFILE FOR MELAMINE PLINTH

Code	Description	NLK
102SKMR	PLINTH CORNER PROF. 155MM BROWN	3083
102SKMV	PLINTH CORNER PROF. 155MM WHITE	3083
102SKMV2700	PLINTH CORNER PROF. 2700MM WHITE	3083



H-PROFILE FOR MELAMINE PLINTH

Code	Description	NLK
102HLV2700	PLINTH H-PROFILE 2700MM WHITE	3083

Accessories

Melamine parts



DRAWER BOTTOM TEN2 WHITE

Code	Description	NLK
LPT03VA	DRAWER BOTTOM TEN 189x495x16 M3 WHITE	0342
LPT04VA	DRAWER BOTTOM TEN 289x495x16 M4 WHITE	0342
LPT05VA	DRAWER BOTTOM TEN 389x495x16 M5 WHITE	0342
LPT06VA	DRAWER BOTTOM TEN 489x495x16 M6 WHITE	0342
LPT07VA	DRAWER BOTTOM TEN 589x495x16 M7 WHITE	0342
LPT08VA	DRAWER BOTTOM TEN 689x495x16 M8 WHITE	0342
LPT09VA	DRAWER BOTTOM TEN 789x495x16 M9 WHITE	0342
LPT10VA	DRAWER BOTTOM TEN 889x495x16 M10 WHITE	0342
LPT12VA	DRAWER BOTTOM TEN 1089x495x16 M12 WHITE	0342

LPT04VA450	DRAWER BOTTOM TEN 289x445x16 WHITE	0342
LPT05VA450	DRAWER BOTTOM TEN 389x445x16 WHITE	0342
LPT06VA450	DRAWER BOTTOM TEN 489x445x16 WHITE	0342
LPT08VA450	DRAWER BOTTOM TEN 689x445x16 WHITE	0342
LPT10VA450	DRAWER BOTTOM TEN 889x445x16 WHITE	0342

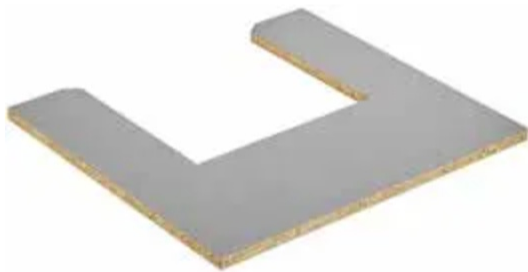

DRAWER BOTTOM TEN2 ANTHRACITE

Code	Description	NLK
LPT03HA	DRAWER BOTTOM TEN 189x495x16 M3 ANTHR	0342
LPT04HA	DRAWER BOTTOM TEN 289x495x16 M4 ANTHR	0342
LPT05HA	DRAWER BOTTOM TEN 389x495x16 M5 ANTHR	0342
LPT06HA	DRAWER BOTTOM TEN 489x495x16 M6 ANTHR	0342
LPT07HA	DRAWER BOTTOM TEN 589x495x16 M7 ANTHR	0342
LPT08HA	DRAWER BOTTOM TEN 689x495x16 M8 ANTHR	0342
LPT09HA	DRAWER BOTTOM TEN 789x495x16 M9 ANTHR	0342
LPT10HA	DRAWER BOTTOM TEN 889x495x16 M10 ANTHR	0342
LPT12HA	DRAWER BOTTOM TEN 1089x495x16 M12 ANTHR	0342

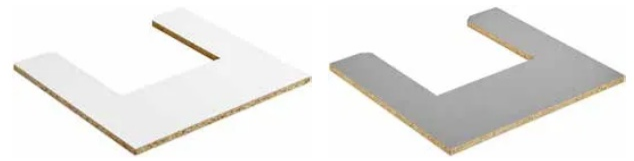

DRAWER BOTTOM TEN2 SINK DRAWER

Code	Description	NLK
LPT06ALLASVA	DRAWER BOTTOM TEN SINK 489x445x16 M6 WHITE	0342
LPT07ALLASVA	DRAWER BOTTOM TEN SINK 589x445x16 M7 WHITE	0342
LPT08ALLASVA	DRAWER BOTTOM TEN SINK 689x445x16 M8 WHITE	0342
LPT06ALLASHA	DRAWER BOTTOM TEN SINK 489x445x16 M6 ANTHRACITE	0342
LPT07ALLASHA	DRAWER BOTTOM TEN SINK 589x445x16 M7 ANTHRACITE	0342
LPT08ALLASHA	DRAWER BOTTOM TEN SINK 689x445x16 M8 ANTHRACITE	0342

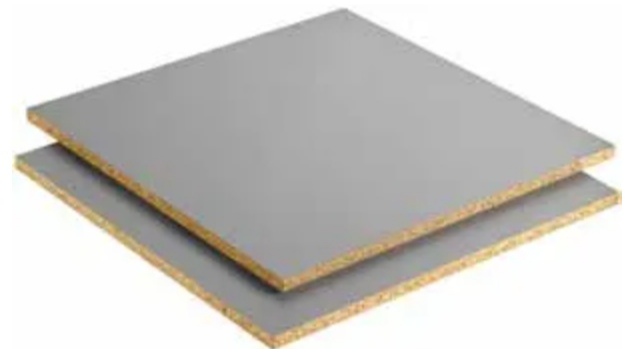

MELAMINE SHELVES

Code	Description	NLK
AKH02VA	SHELF 165x538x16 WHITE MEL.	3071
AKH03VA	SHELF 265x538x16 WHITE MEL.	3071
AKH04VA	SHELF 365x538x16 WHITE MEL.	3071
AKH045VA	SHELF 415x538x16 WHITE MEL.	3071
AKH05VA	SHELF 465x538x16 WHITE MEL.	3071
AKH06VA	SHELF 565x538x16 WHITE MEL.	3071
AKH07VA	SHELF 665x538x16 WHITE MEL.	3071
AKH08VA	SHELF 765x538x16 WHITE MEL.	3071
AKH09VA	SHELF 865x538x16 WHITE MEL.	3071
AKH10VA	SHELF 965x538x16 WHITE MEL.	3071
AKH12V	SHELF 1165x538x16 WHITE MEL.	3071
AKH9X9	SHELF 895x895x16 WHITE MEL.	3071
3800000148	SHELF SUPPORT ZINC 5*16 WITH COLLAR	2010

- Color: white
- Front edge edge-banded

Accessories



PLINTH LEGS

Code	Description	NLK
94P152522	PLINTH LEG 150 QUICK RELEASE 15	0830
C93P152522	PLINTH LEG 100 QUICK RELEASE 15	0830
C94PTST22	PLINTH LEG 150 SCREW FIXING	0830
C93PTST22	PLINTH LEG 100 SCREW FIXING	0830

Plinth leg 100 set includes:

- leg 102 mm – 132 mm (4 pcs)
- leg fixing screws 4*35 mm (8 pcs)
- fixing clip for board plinth (4 pcs)
- fixing clip for plastic plinth (4 pcs)

Load capacity is 106 kg / leg

Plinth leg 150 set includes:

- leg 132 mm – 200 mm (4 pcs)
- leg fixing screws 4*35 mm (8 pcs)
- fixing clip for board plinth (4 pcs)
- fixing clip for plastic plinth (4 pcs)

Load capacity is 75 kg / leg

Box packaging size: 50 sets



ROLLER CATCH FOR CABINET DOOR

Code	Description	NLK
F23800	ROLLER CATCH FOR CABINET DOOR	2010



HANDLE SCREW

Code	Description	NLK
09558150	HANDLE SCREW M4*20MM	2010
09558160	HANDLE SCREW M4*23MM	2010
09558170	HANDLE SCREW M4*25MM	2010

Bag includes:

- 40 pcs handle screws



MOUNTING ACCESSORY SET

Code	Description	NLK
095765664	MOUNTING ACCESSORY SET 1	2010

The mounting accessory set includes the following products:

- Euro screw 6.2*12, PZ2 (30 pcs)
- Screw 4*16 mm, PZ2 (100 pcs)
- Screw 4*30 mm, PZ2 (100 pcs)
- Furniture angle bracket 30*27 mm (20 pcs)
- Cover cap 8 mm, white (20 pcs)
- Cover cap 5 mm, white (20 pcs)
- Cover cap 15 mm, white (8 pcs)
- Adhesive cover cap 13 mm, white (36 pcs)
- Screwdriver bit PZ2 (1 pc)
- Screwdriver bit SW3 (1 pc)
- Adhesive damper pad 3*10 mm, clear (50 pcs)



SCREW BAG 1

Code	Description	NLK
09558130	SCREW BAG 1	2010

Bag includes:

- 20 pcs euro screw PZ6.3X7.0X11 mm zinc-plated
- 20 pcs wood screw PZ4.0/8.0x16 mm zinc-plated



SCREW BAG 2

Code	Description	NLK
09558140	SCREW BAG 2	2010

Bag includes:

- 20 pcs wood screws PZ4.0/8.0x16 mm

Accessories



COVER CAP 8 MM

Code	Description	Price Group
F21001	COVER CAP 5MM WHITE	2010
F21051	COVER CAP 8MM WHITE	2010



ASSEMBLY SCREW FOR CABINET FRAMES & COVER CAP

Code	Description	Price Group
PF23003	ASSEMBLY SCREW FOR CABINET FRAMES	2010
F21021	ASSEMBLY SCREW COVER CAP WHITE	2010

PF23003 assembly screw 5*50 for cabinet frames



ELECTRICAL OUTLET COVER PLATE

Code	Description	Price Group
380001	ELECTRICAL OUTLET COVER PLATE, COLLAR	2010

- With inward-facing collar
- External dimensions: 155*155 mm
- Installation dimension: 85*85 mm
- Collar depth: 15 mm



PENETRATION PROTECTOR / PLUG LEAD-THROUGH COLLAR

Code	Description	Price Group
380002	PLUG LEAD-THROUGH COLLAR	2010

- Color: white
- Dimensions: installation hole 60 mm and inner hole 55 mm
- Also suitable for ventilation penetrations



PENETRATION SLEEVE HARDWARE PACK

Code	Description	Price Group
380003	SINK CABINET SEALING KIT	2010

Seals penetrations and protects against water damage. Suitable for most sink cabinet and dishwasher models.

- Aqua Tăt sealant 40 ml
- Dishwasher penetration Ø 84 mm
- Sealing collar Ø 15-19 mm 2 pcs
- Sealing collar Ø 21-26 mm 2 pcs
- Sealing collar Ø 45-55 mm 1 pc
- Sealing strips: 45 mm 1 pc, 65 mm 2 pcs, 75 mm 2 pcs, and 110 mm 1 pc



SINK SUPPORT ARCH

Code	Description	Price Group
PF21961	SINK ARCH 66*120*257	2010



411781720TATIM SPA OPLA 900 EXTENDABLE WORKTOP MECHANISM





Breakfast & Tambour Door Cabinets

- An excellent and stylish solution where necessary items are kept neatly out of sight but within easy reach.
- The structure of the tambour door cabinet frames works with the breakfast cabinet concept, where dimensions are designed to accommodate common small home appliances such as microwave ovens and coffee makers.
- Milano Box tambour doors fit standard cabinet frames but can also be custom-made for cabinet frames of different sizes with a board thickness of 16 mm.
- Milano Box tambour doors are ordered using the Stella ordering tool, and their delivery time is 7 working days from the order.



Tambour Door Cabinets



TAMBOUR DOOR CABINET FRAMES

- Standard cabinet frames suitable for Milano Box tambour doors.
- The frame is suitable for use with tambour door mechanisms or breakfast cabinet pocket door mechanisms.
- Height: 1212 mm. The height of the cabinet is dimensioned to be placed on top of a base cabinet.
- The cabinet has a 16 mm melamine base. Can also be used without a base on top of a worktop.
- Depth: 560 mm
- Widths: 600, 700, 800, 900, 1000, 1200 mm
- Shelves can be omitted if necessary
- Shelves are locked in place with connecting fittings (rafix)
- Shelves are not adjustable
- The depth of the top shelf is 490 mm
- The depth of the two lower shelves is 311 mm
- The base can also be made from a worktop, in which case a worktop with the correct dimensions must be ordered (width = module dimension – 32 mm and depth 540 mm). The base is placed between the cabinet sides.

TAMBOUR DOOR CABINET FRAMES

Code	Description	Price Group
KRO06	TAMBOUR DOOR CABINET M6 1212*600*560	3064
KRO07	TAMBOUR DOOR CABINET M7 1212*700*560	3064
KRO08	TAMBOUR DOOR CABINET M8 1212*800*560	3064
KRO09	TAMBOUR DOOR CABINET M9 1212*900*560	3064
KRO10	TAMBOUR DOOR CABINET M10 1212*1000*560	3064
KRO121	TAMBOUR DOOR CABINET M12 1212*1200*560	3064

BREAKFAST CABINET INTERMEDIATE BASE

Code	Description	Price Group
B70VA	BREAKFAST CABINET INT. BASE 668x539 M70	3071
B80VA	BREAKFAST CABINET INT. BASE 768x539 M80	3071
B90VA	BREAKFAST CABINET INT. BASE 868x539 M90	3071
B100VA	BREAKFAST CABINET INT. BASE 968x539 M100	3071

B2 INOX Mill (Stainless steel look)

M4 White matt

L2 Black matt

MILANO BOX TAMBOUR DOORS

- Tambour doors can be manufactured for cabinet frames of different sizes with a board thickness of 16 mm.
- **Min/Max dimensions for cabinet frames:**
 - Width min. 400 mm, max. 1200 mm
 - Height min. 500 mm, max. 1500 mm
 - Internal depth min. 305 mm
- Tambour material is aluminum, slat height is 40 mm.
- **Tambours can be manufactured in three different colors:**
 - B2 INOX Mill (Stainless steel look)
 - M4 White matt
 - L2 Black matt
- Delivery time is 7 working days from the order
- Milano Box tambour doors are ordered using the Stella ordering tool.



Breakfast Cabinets



BREAKFAST CABINET HEIGHT 1922 MM

The breakfast cabinet track set includes:

- Pocket door mechanism DZ1319-0055, 2 pairs
- Pocket door rack and pinion kit DZ1316-0055, 2 pairs
- Rod 2 m DZ61040, 2 pcs
- Breakfast cabinet template/Riser for tracks, 1 set
- Hole plug white Ø36 mm, 6 pcs
- Breakfast cabinet filler strip 1835x60x16 Mel white, 2 pcs
- Soft-close hinges Omnia L 105 C0 X-P + mounting plate Omnia 3D K0 Euro screw, 6 pcs
- Adhesive brush seal for breakfast cabinet 4m, 1 pc

NOTE! We recommend using cover panels on both sides.

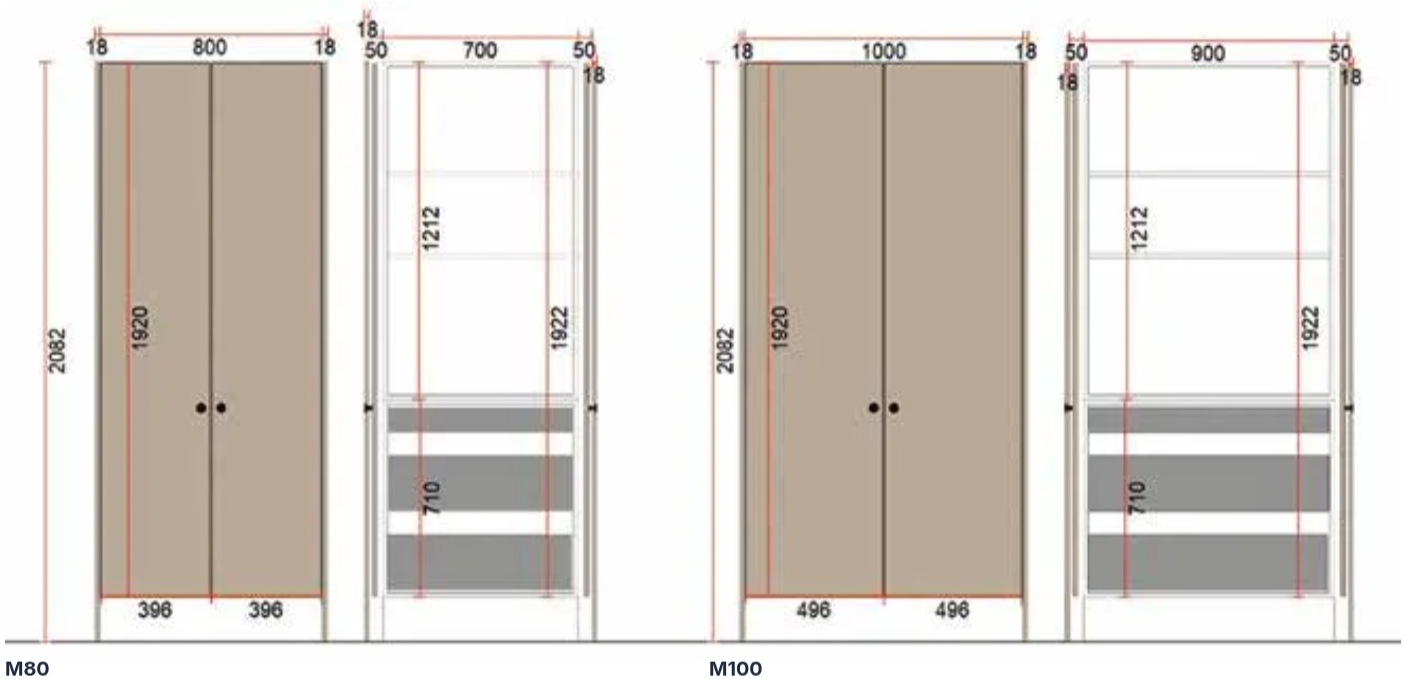

M80

M100

ORDERING INSTRUCTIONS 1922 MM / REQUIRED PRODUCTS FOR A COMPLETE PACKAGE:

Breakfast cabinet width	M70	M80	M90	M100
TOP PART				
Frame	Code: KRO06 TAMBOUR CABINET M6 1212*600*560	Code: KRO07 TAMBOUR CABINET M7 1212*700*560	Code: KRO08 TAMBOUR CABINET M8 1212*800*560	Code: KRO09 TAMBOUR CABINET M9 1212*900*560
BOTTOM PART				
Frame	Code: A06PR BASE CABINET 710*600*560 Also order desired drawers etc. equipment.	Code: A07PR BASE CABINET 710*700*560 Also order desired drawers etc. equipment.	Code: A08PR BASE CABINET 710*800*560 Also order desired drawers etc. equipment.	Code: A09PR BASE CABINET 710*900*560 Also order desired drawers etc. equipment.
DOORS				
Door dimension	1920*346 Note! Custom dimension Door drilling 130/8 3 hinges (130/8 + center)	1920*396 Note! Custom dimension Door drilling 130/8 3 hinges (130/8 + center)	1920*446 Note! Custom dimension Door drilling 130/8 3 hinges (130/8 + center)	1920*496 Note! Custom dimension Door drilling 130/8 3 hinges (130/8 + center)
TRACK SET				
	Code: AAMIAISKAAPPI TRACKS BREAKFAST CABINET TRACK SET 1922 mm HIGH	Code: AAMIAISKAAPPI TRACKS BREAKFAST CABINET TRACK SET 1922 mm HIGH	Code: AAMIAISKAAPPI TRACKS BREAKFAST CABINET TRACK SET 1922 mm HIGH	Code: AAMIAISKAAPPI TRACKS BREAKFAST CABINET TRACK SET 1922 mm HIGH

Breakfast Cabinets

BREAKFAST CABINET HEIGHT 1212 MM

Breakfast cabinet track set 2 includes:

- Pocket door mechanism DZ1319-0055, 2 pairs
- Pocket door rack and pinion kit DZ1316-0055, 2 pairs
- Rod 2 m DZ61040, 2 pcs
- Breakfast cabinet template/Riser for tracks, 1 set
- Hole plug white Ø36 mm, 4 pcs
- Breakfast cabinet filler strip 1123x60x16 Mel white, 2 pcs
- Soft-close hinges Omnia L 105 C0 X-P + mounting plate Omnia 3D K0 Euro screw, 4 pcs
- Adhesive brush seal for breakfast cabinet 4m, 1 pc

NOTE! We recommend using cover panels on both sides.

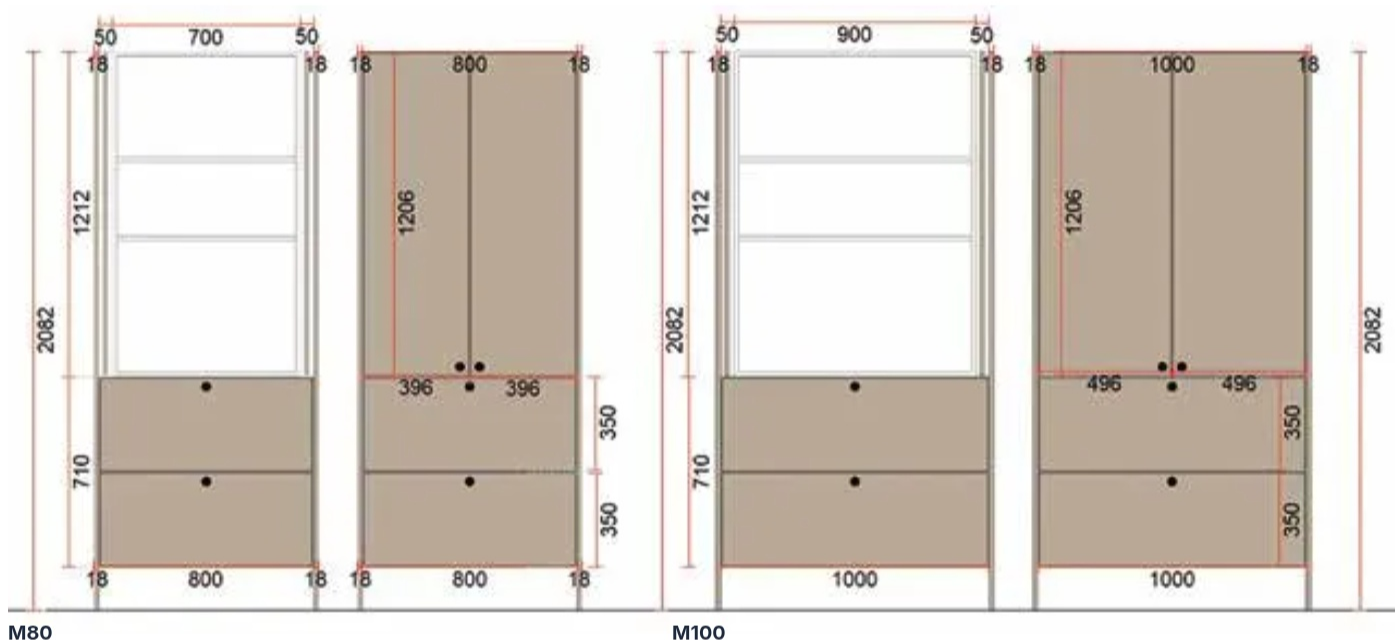

ORDERING INSTRUCTIONS 1212 MM / REQUIRED PRODUCTS FOR A COMPLETE PACKAGE:

Breakfast cabinet width	M70	M80	M90	M100
TOP PART				
Frame	Code: KRO06 TAMBOUR CABINET M6	Code: KRO07 TAMBOUR CABINET M7	Code: KRO08 TAMBOUR CABINET M8	Code: KRO09 TAMBOUR CABINET M9
Door dimension	1212*600*560 1206*346 Note! Custom dimension Door drilling 130/8	1212*700*560 1206*396 Note! Custom dimension Door drilling 130/8	1212*800*560 1206*446 Note! Custom dimension Door drilling 130/8	1212*900*560 1206*496 Note! Custom dimension Door drilling 130/8
BOTTOM PART				
Frame	Code: A07PR BASE CABINET 710*700*560	Code: A08PR BASE CABINET 710*800*560	Code: A09PR BASE CABINET 710*900*560	Code: A10PR BASE CABINET 710*1000*560
Intermediate base	Code: B70VA BREAKFAST CABINET INT. BASE 668x539 M70 Also order desired drawers etc. equipment.	Code: B80VA BREAKFAST CABINET INT. BASE 768x539 M80 Also order desired drawers etc. equipment.	Code: B90VA BREAKFAST CABINET INT. BASE 868x539 M90 Also order desired drawers etc. equipment.	Code: B100VA BREAKFAST CABINET INT. BASE 968x539 M100 Also order desired drawers etc. equipment.
Door dimension	137/278/350*696, 703*346	137/278/350*796, 703*396	137/278/350*896, 703*446	137/278/350*996, 703*496
TRACK SET	Code: AAMIAISKAAP. KISKOT 2 BREAKFAST CABINET TRACK SET 1212 mm HIGH	Code: AAMIAISKAAP. KISKOT 2 BREAKFAST CABINET TRACK SET 1212 mm HIGH	Code: AAMIAISKAAP. KISKOT 2 BREAKFAST CABINET TRACK SET 1212 mm HIGH	Code: AAMIAISKAAP. KISKOT 2 BREAKFAST CABINET TRACK SET 1212 mm HIGH

[Link to installation instructions page 55](#)



1. Door Drillings

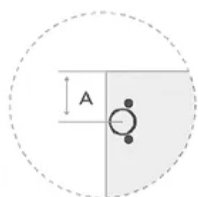

100/8 side	
A	100 mm
Hinging	Side
Fixing	Quick-mount
Code	11110081

100/8 top hinging	
A	100 mm
Hinging	Top
Fixing	Quick-mount
Code	11110081Y

75/8 (1214 mm int. fridge)	
A	75 mm
Hinging	Side
Fixing	Quick-mount
Code	1117501

55/8 (278 mm door)	
A	55 mm
Hinging	Side
Fixing	Quick-mount
Code	1115501

Note! Integra and Finger Pull door models:

55/8 side hinging cannot be used. All doors with a height of 278 mm or less must be top-hinged.

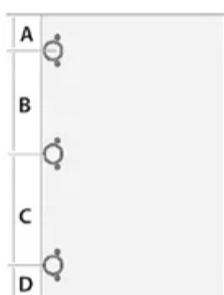

Int. Refrigerator 1920 mm door	
A	75 mm
B	1064 mm
C	681 mm
D	100 mm
Hinging	Side
Fixing	Quick-mount
Code	1117503

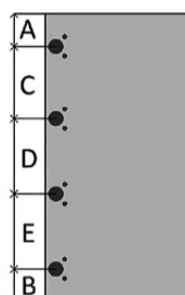

2200 mm door (equal spacing)	
A	100 mm
B	100 mm
C	667 mm
D	666 mm
E	667 mm
Hinging	Side
Fixing	Quick-mount
Code	111100812200

2. Special Door Drillings

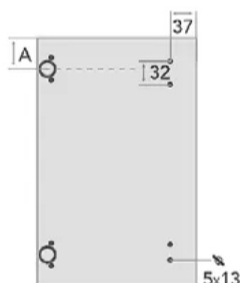

100/8 side base corner	
Drilling	5x13
A	100 mm
Hinging	side
Fixing	quick-mount
Code	11110081K

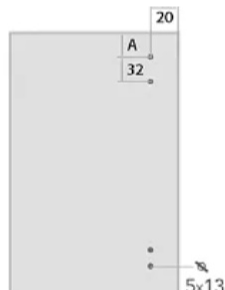

Cover panel drilling	
Drilling	5x13
A	88 mm
Code	11110083

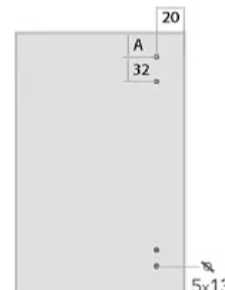

Cover panel wall corner drilling	
Drilling	5x13
A	85 mm
Code	11110084

For INTEGRA AND FINGER PULL door models, please note the pull groove dimensions and placement on the doors. Drillings differ in some parts compared to standard door profiles. Doors are always treated as base doors; when stating handedness, note that the pull groove is at the top. In top-hinged doors, the pull groove is at the bottom.

3. Front Panel Drillings

Low front panel drilling: TEN 2 - drawer



TEN 2 low

A	61 mm
B	29 mm
C	32 mm
D	10 mm
Code	11CCTEN2MAT

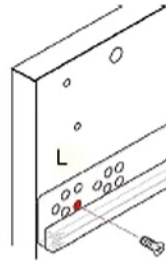

Note!

137 mm high front panel drawer rail must be fixed from the top row of holes of the rail.

Low front panel drilling: other mechanisms



Uniset 53 mark.

A	29 mm
B	22 mm
C	32 mm
D	2 mm
Code	11CCUNISETUUNI

Ironing board

A	32 mm
B	47 mm
C	52 mm
D	2 mm
Code	11CCSILA

Cutting board

A	12 mm
B	34 mm
C	20 mm
D	2 mm
Code	11CCLELA

DRILLING TEN2 TOP-MOUNTED WASTE BIN FRAME AND TEN2 BASKET

A	264 mm
B	29 mm
C	32 mm
D	10 mm
Code	11CCTEN2JATYK

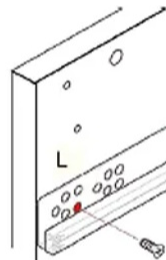

Note!

350, 562, 703 mm top-mounted waste bin rail behind the front panel must be fixed from the top row of holes of the rail.

DRILLING TEN2 TOP-MOUNTED WASTE BIN FRAME AND TEN2 BASKET UPPER DRAWER

A	252 mm
B	29 mm
C	32 mm
D	10 mm
Code	11CCTEN2JATYKYLÄ

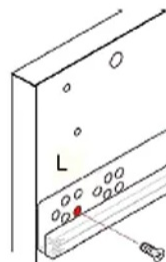

Note!

Topmost 350 mm front panel top-mounted waste bin rail must be fixed from the bottom row of holes of the rail.

ENVI SPACE WASTE BIN MECHANISM

A	134 mm
B	32 mm
C	96 mm
D	2 mm
Code	11CCOKOLINER

ENVI SPACE XX WASTE BIN MECHANISM

A	303 mm
B	28 mm
C	96 mm
D	2 mm
Code	11CCENVISPACEXX

4. Front Panel Drillings

High front panel drilling for TEN 2 drawer

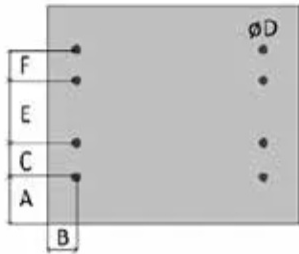

TEN 2 high

A	72 mm
B	29 mm
C	32 mm
E	64 mm
F	32 mm
D	10 mm
Code	11CCTEN2KOR

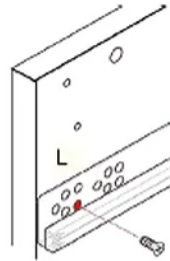

Note!

278 and 350 mm high front panel drawer runners must be attached to the lowest row of holes in the runner.

High front panel drilling for TEN 2 sink drawer

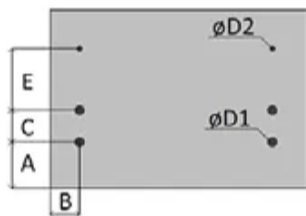

TEN 2 SINK DRAWER

A	72 mm
B	29 mm
C	32 mm
E	64 mm
D1	10 mm
D2	2 mm
Code	11CCTEN2ALLASLTK

D-LITE lift-up mechanism

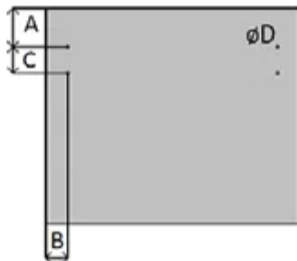

D-LITE lift-up mechanism

A	79 mm
B	26 mm
C	64 mm
D	2 mm
Code	11CCDLITE





KK6UM CABINET RUNNER AND SHELF MOUNTING HOLES

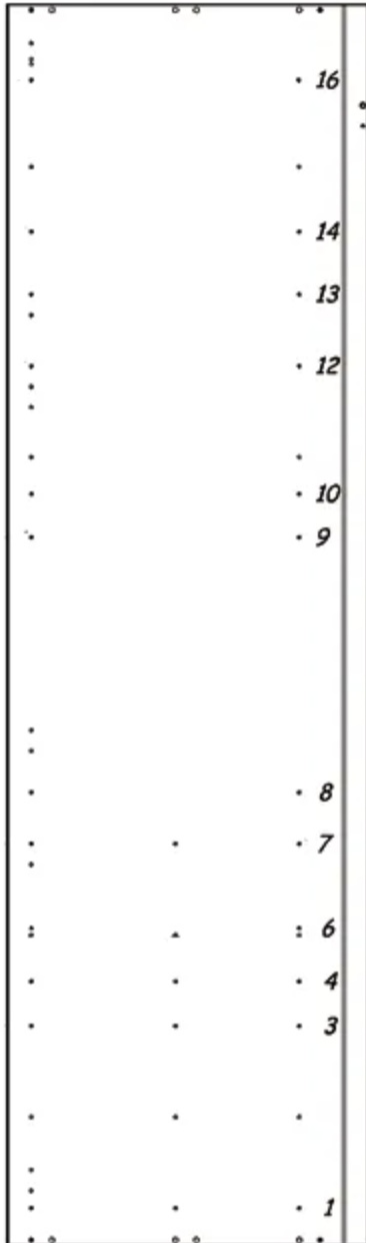

INT. Refrigerator

shelf → row 16

INT. Oven

shelf → row 8, 12

INT. Oven

shelf → row 8, 12

drawer runners → row 1, 3, 7

INT. Microwave 460

shelf → row 8, 10

INT. Microwave 460

shelf → row 8, 10

drawer runners → row 1, 3, 7

INT. Oven + microwave 460

shelf → row 6, 9, 14

drawer runners → row 1, 4

INT. Oven + microwave 370

shelf → row 6, 9, 14

drawer runners → row 1, 4

INT. Oven

shelf → row 8, 12

drawer unit runners → row 1, 4

INT. Microwave 460

shelf → row 8, 10

drawer unit runners → row 1, 4

NOTE! Drawer unit holes are dimensioned for profile drawer runners.

KYM... CABINET RUNNER MOUNTING HOLES

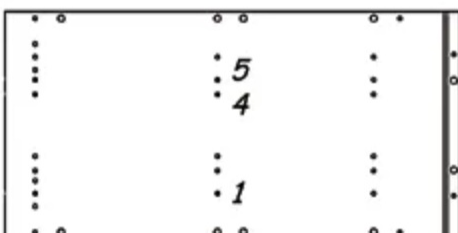

KYM...PR_1 → runner row 1 - Profile drawer

OMMA
MONTERING